

Reliable Basic Switch with External Lever

- Available by 21 A, 16 A, 11 A, 6 A and 0.1 A models, all with self-cleaning contacts.
- Available with internally or externally fitted levers, and 2 fixing positions for external levers.

RoHS Compliant

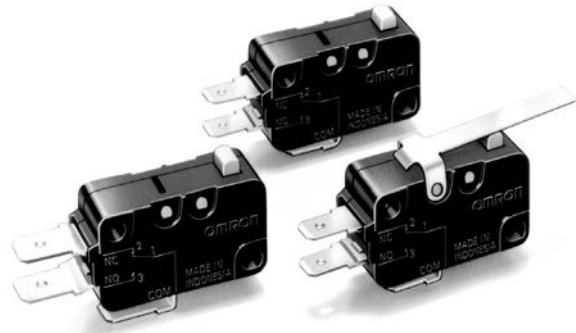

Ordering Information

Model Number Legend

D3V-□□□□-□□□□-□□□
 1 2 3 4 5 6 7 8 9

1. Ratings

- 21: 20 (4) A at 250 VAC
- 16: 16 (3) A at 250 VAC
- 11: 11 (3) A at 250 VAC
- 6: 6 (2) A at 250 VAC
- 01: 0.1 A at 125 VAC

2. Contact Gap

- None: 1 mm (F gap)
- G: 0.5 mm (G gap)

3. Actuator

- None: Pin plunger
- 1: Short hinge lever
- 2: Hinge lever
- 3: Long hinge lever
- 4: Simulated roller lever
- 5: Short hinge roller lever
- 6: Hinge roller lever

4. Hinge Position

- None: Internal/Far from plunger
- M: External/Far from plunger
- K: External/Near plunger

5. Contact Form

- 1: SPDT
- 2: SPST-NC
- 3: SPST-NO

6. Terminals

- A: Solder terminals
- C2: Quick-connect terminals (#187)
- C: Quick-connect terminals (#250)

7. Maximum Operating Force

- 5: 1.96 N {200 gf}
- 4A: 1.23 N {125 gf}
- 4: 0.98 N {100 gf}
- 3: 0.49 N {50 gf}
- 2: 0.25 N {25 gf}

Note: These values are for the pin plunger models.

8. Mounting Hole Size

- None: 3.1 mm
- K: 2.9 mm







9. Special Code

- None: Standard
- H: High temperature (125°C) (See note)
- E: Special rating: 21 (8) A

Note: Consult your OMRON sales representative for high temperature models.







List of Models

• 21 A (OF: 1.23 N {125 gf})

Actuator	Hinge position	Maximum Operating Force (OF)	Contact form		
			SPDT	SPST-NC	SPST-NO
Pin plunger 	---	1.23N {125gf}	D3V-21G-1□4A-Δ	D3V-21G-2□4A-Δ	D3V-21G-3□4A-Δ
Short hinge lever 	Internal	1.23N {125gf}	D3V-21G1-1□4A-Δ	D3V-21G1-2□4A-Δ	D3V-21G1-3□4A-Δ
	M		D3V-21G1M-1□4A-Δ	D3V-21G1M-2□4A-Δ	D3V-21G1M-3□4A-Δ
Hinge lever 	Internal	0.78N {80gf}	D3V-21G2-1□4A-Δ	D3V-21G2-2□4A-Δ	D3V-21G2-3□4A-Δ
	M		D3V-21G2M-1□4A-Δ	D3V-21G2M-2□4A-Δ	D3V-21G2M-3□4A-Δ
Long hinge lever 	Internal	0.44N {45gf}	D3V-21G3-1□4A-Δ	D3V-21G3-2□4A-Δ	D3V-21G3-3□4A-Δ
	M		D3V-21G3M-1□4A-Δ	D3V-21G3M-2□4A-Δ	D3V-21G3M-3□4A-Δ
Simulated roller lever 	Internal	0.83N {85gf}	D3V-21G4-1□4A-Δ	D3V-21G4-2□4A-Δ	D3V-21G4-3□4A-Δ
	M		D3V-21G4M-1□4A-Δ	D3V-21G4M-2□4A-Δ	D3V-21G4M-3□4A-Δ
Short hinge roller lever 	Internal	1.42N {145gf}	D3V-21G5-1□4A-Δ	D3V-21G5-2□4A-Δ	D3V-21G5-3□4A-Δ
	M		D3V-21G5M-1□4A-Δ	D3V-21G5M-2□4A-Δ	D3V-21G5M-3□4A-Δ
Hinge roller lever 	Internal	0.79N {80gf}	D3V-21G6-1□4A-Δ	D3V-21G6-2□4A-Δ	D3V-21G6-3□4A-Δ
	M		D3V-21G6M-1□4A-Δ	D3V-21G6M-2□4A-Δ	D3V-21G6M-3□4A-Δ







Note: The □ in the model number is for the terminal code.
 C: Quick-connect terminals (#250)
 The Δ in the model number is for the mounting hole size.
 None: 3.1 mm
 K: 2.9 mm

• 16 A (OF: 1.96 N {200 gf})







Actuator	Hinge position	Maximum Operating Force (OF)	Contact form		
			SPDT	SPST-NC	SPST-NO
Pin plunger 	---	1.96N {200gf}	D3V-16-1□5-Δ	D3V-16-2□5-Δ	D3V-16-3□5-Δ
Short hinge lever 	Internal	1.96N {200gf}	D3V-161-1□5-Δ	D3V-161-2□5-Δ	D3V-161-3□5-Δ
	M		D3V-161M-1□5-Δ	D3V-161M-2□5-Δ	D3V-161M-3□5-Δ
Hinge lever 	Internal	1.23N {125gf}	D3V-162-1□5-Δ	D3V-162-2□5-Δ	D3V-162-3□5-Δ
	M		D3V-162M-1□5-Δ	D3V-162M-2□5-Δ	D3V-162M-3□5-Δ
Long hinge lever 	Internal	0.69N {70gf}	D3V-163-1□5-Δ	D3V-163-2□5-Δ	D3V-163-3□5-Δ
	M		D3V-163M-1□5-Δ	D3V-163M-2□5-Δ	D3V-163M-3□5-Δ
Simulated roller lever 	Internal	1.23N {125gf}	D3V-164-1□5-Δ	D3V-164-2□5-Δ	D3V-164-3□5-Δ
	M		D3V-164M-1□5-Δ	D3V-164M-2□5-Δ	D3V-164M-3□5-Δ
Short hinge roller lever 	Internal	2.35N {240gf}	D3V-165-1□5-Δ	D3V-165-2□5-Δ	D3V-165-3□5-Δ
	M		D3V-165M-1□5-Δ	D3V-165M-2□5-Δ	D3V-165M-3□5-Δ
Hinge roller lever 	Internal	1.23N {125gf}	D3V-166-1□5-Δ	D3V-166-2□5-Δ	D3V-166-3□5-Δ
	M		D3V-166M-1□5-Δ	D3V-166M-2□5-Δ	D3V-166M-3□5-Δ

Note: The □ in the model number is for the terminal code.
 A: Solder terminals
 C2: Quick-connect terminals (#187)
 C: Quick-connect terminals (#250)
 The Δ in the model number is for the mounting hole size.
 None: 3.1 mm
 K: 2.9 mm

- 16 A (OF: 0.98 N {100 gf})

Actuator	Hinge position	Maximum Operating Force (OF)	Contact form		
			SPDT	SPST-NC	SPST-NO
Pin plunger 	---	0.98N {100gf}	D3V-16-1□4-Δ	D3V-16-2□4-Δ	D3V-16-3□4-Δ
Short hinge lever 	Internal	0.98N {100gf}	D3V-161-1□4-Δ	D3V-161-2□4-Δ	D3V-161-3□4-Δ
	M		D3V-161M-1□4-Δ	D3V-161M-2□4-Δ	D3V-161M-3□4-Δ
Hinge lever 	Internal	0.59N {60gf}	D3V-162-1□4-Δ	D3V-162-2□4-Δ	D3V-162-3□4-Δ
	M		D3V-162M-1□4-Δ	D3V-162M-2□4-Δ	D3V-162M-3□4-Δ
Long hinge lever 	Internal	0.34N {35gf}	D3V-163-1□4-Δ	D3V-163-2□4-Δ	D3V-163-3□4-Δ
	M		D3V-163M-1□4-Δ	D3V-163M-2□4-Δ	D3V-163M-3□4-Δ
Simulated roller lever 	Internal	0.59N {60gf}	D3V-164-1□4-Δ	D3V-164-2□4-Δ	D3V-164-3□4-Δ
	M		D3V-164M-1□4-Δ	D3V-164M-2□4-Δ	D3V-164M-3□4-Δ
Short hinge roller lever 	Internal	1.18N {120gf}	D3V-165-1□4-Δ	D3V-165-2□4-Δ	D3V-165-3□4-Δ
	M		D3V-165M-1□4-Δ	D3V-165M-2□4-Δ	D3V-165M-3□4-Δ
Hinge roller lever 	Internal	0.59N {60gf}	D3V-166-1□4-Δ	D3V-166-2□4-Δ	D3V-166-3□4-Δ
	M		D3V-166M-1□4-Δ	D3V-166M-2□4-Δ	D3V-166M-3□4-Δ

- 11 A (OF: 1.96 N {200 gf})

Actuator	Hinge position	Maximum Operating Force (OF)	Contact form		
			SPDT	SPST-NC	SPST-NO
Pin plunger 	---	1.96N {200gf}	D3V-11-1□5-Δ	D3V-11-2□5-Δ	D3V-11-3□5-Δ
Short hinge lever 	Internal	1.96N {200gf}	D3V-111-1□5-Δ	D3V-111-2□5-Δ	D3V-111-3□5-Δ
	M		D3V-111M-1□5-Δ	D3V-111M-2□5-Δ	D3V-111M-3□5-Δ
Hinge lever 	Internal	1.23N {125gf}	D3V-112-1□5-Δ	D3V-112-2□5-Δ	D3V-112-3□5-Δ
	M		D3V-112M-1□5-Δ	D3V-112M-2□5-Δ	D3V-112M-3□5-Δ
Long hinge lever 	Internal	0.69N {70gf}	D3V-113-1□5-Δ	D3V-113-2□5-Δ	D3V-113-3□5-Δ
	M		D3V-113M-1□5-Δ	D3V-113M-2□5-Δ	D3V-113M-3□5-Δ
Simulated roller lever 	Internal	1.23N {125gf}	D3V-114-1□5-Δ	D3V-114-2□5-Δ	D3V-114-3□5-Δ
	M		D3V-114M-1□5-Δ	D3V-114M-2□5-Δ	D3V-114M-3□5-Δ
Short hinge roller lever 	Internal	2.35N {240gf}	D3V-115-1□5-Δ	D3V-115-2□5-Δ	D3V-115-3□5-Δ
	M		D3V-115M-1□5-Δ	D3V-115M-2□5-Δ	D3V-115M-3□5-Δ
Hinge roller lever 	Internal	1.23N {125gf}	D3V-116-1□5-Δ	D3V-116-2□5-Δ	D3V-116-3□5-Δ
	M		D3V-116M-1□5-Δ	D3V-116M-2□5-Δ	D3V-116M-3□5-Δ

Note: The □ in the model number is for the terminal code.

A: Solder terminals

C2: Quick-connect terminals (#187)







C: Quick-connect terminals (#250)

The Δ in the model number is for the mounting hole size.

None: 3.1 mm







K: 2.9 mm

- 11 A (OF: 0.98 N {100 gf})







Actuator	Hinge position	Maximum Operating Force (OF)	Contact form		
			SPDT	SPST-NC	SPST-NO
Pin plunger 	---	0.98N {100gf}	D3V-11-1□4-Δ	D3V-11-2□4-Δ	D3V-11-3□4-Δ
Short hinge lever 	Internal	0.98N {100gf}	D3V-111-1□4-Δ	D3V-111-2□4-Δ	D3V-111-3□4-Δ
	M		D3V-111M-1□4-Δ	D3V-111M-2□4-Δ	D3V-111M-3□4-Δ
Hinge lever 	Internal	0.59N {60gf}	D3V-112-1□4-Δ	D3V-112-2□4-Δ	D3V-112-3□4-Δ
	M		D3V-112M-1□4-Δ	D3V-112M-2□4-Δ	D3V-112M-3□4-Δ
Long hinge lever 	Internal	0.34N {35gf}	D3V-113-1□4-Δ	D3V-113-2□4-Δ	D3V-113-3□4-Δ
	M		D3V-113M-1□4-Δ	D3V-113M-2□4-Δ	D3V-113M-3□4-Δ
Simulated roller lever 	Internal	0.59N {60gf}	D3V-114-1□4-Δ	D3V-114-2□4-Δ	D3V-114-3□4-Δ
	M		D3V-114M-1□4-Δ	D3V-114M-2□4-Δ	D3V-114M-3□4-Δ
Short hinge roller lever 	Internal	1.18N {120gf}	D3V-115-1□4-Δ	D3V-115-2□4-Δ	D3V-115-3□4-Δ
	M		D3V-115M-1□4-Δ	D3V-115M-2□4-Δ	D3V-115M-3□4-Δ
Hinge roller lever 	Internal	0.59N {60gf}	D3V-116-1□4-Δ	D3V-116-2□4-Δ	D3V-116-3□4-Δ
	M		D3V-116M-1□4-Δ	D3V-116M-2□4-Δ	D3V-116M-3□4-Δ

Note: The □ in the model number is for the terminal code.
A: Solder terminals
C2: Quick-connect terminals (#187)
C: Quick-connect terminals (#250)
The Δ in the model number is for the mounting hole size.
None: 3.1 mm
K: 2.9 mm

• 6 A (OF: 0.98 N {100 gf})

Actuator	Hinge position	Maximum Operating Force (OF)	Contact form		
			SPDT	SPST-NC	SPST-NO
Pin plunger 	---	0.98N {100gf}	D3V-6-1□4-Δ	D3V-6-2□4-Δ	D3V-6-3□4-Δ
Short hinge lever 	Internal	0.98N {100gf}	D3V-61-1□4-Δ	D3V-61-2□4-Δ	D3V-61-3□4-Δ
	M		D3V-61M-1□4-Δ	D3V-61M-2□4-Δ	D3V-61M-3□4-Δ
Hinge lever 	Internal	0.59N {60gf}	D3V-62-1□4-Δ	D3V-62-2□4-Δ	D3V-62-3□4-Δ
	M		D3V-62M-1□4-Δ	D3V-62M-2□4-Δ	D3V-62M-3□4-Δ
Long hinge lever 	Internal	0.34N {35gf}	D3V-63-1□4-Δ	D3V-63-2□4-Δ	D3V-63-3□4-Δ
	M		D3V-63M-1□4-Δ	D3V-63M-2□4-Δ	D3V-63M-3□4-Δ
Simulated roller lever 	Internal	0.59N {60gf}	D3V-64-1□4-Δ	D3V-64-2□4-Δ	D3V-64-3□4-Δ
	M		D3V-64M-1□4-Δ	D3V-64M-2□4-Δ	D3V-64M-3□4-Δ
Short hinge roller lever 	Internal	1.18N {120gf}	D3V-65-1□4-Δ	D3V-65-2□4-Δ	D3V-65-3□4-Δ
	M		D3V-65M-1□4-Δ	D3V-65M-2□4-Δ	D3V-65M-3□4-Δ
Hinge roller lever 	Internal	0.59N {60gf}	D3V-66-1□4-Δ	D3V-66-2□4-Δ	D3V-66-3□4-Δ
	M		D3V-66M-1□4-Δ	D3V-66M-2□4-Δ	D3V-66M-3□4-Δ

• 6 A (OF: 0.49 N {50 gf})

Actuator	Hinge position	Maximum Operating Force (OF)	Contact form		
			SPDT	SPST-NC	SPST-NO
Pin plunger 	---	0.49N {50gf}	D3V-6G-1□3-Δ	D3V-6G-2□3-Δ	D3V-6G-3□3-Δ
Short hinge lever 	Internal	0.49N {50gf}	D3V-6G1-1□3-Δ	D3V-6G1-2□3-Δ	D3V-6G1-3□3-Δ
	M		D3V-6G1M-1□3-Δ	D3V-6G1M-2□3-Δ	D3V-6G1M-3□3-Δ
Hinge lever 	Internal	0.59N {60gf}	D3V-6G2-1□3-Δ	D3V-6G2-2□3-Δ	D3V-6G2-3□3-Δ
	M		D3V-6G2M-1□3-Δ	D3V-6G2M-2□3-Δ	D3V-6G2M-3□3-Δ
Long hinge lever 	Internal	0.20N {20gf}	D3V-6G3-1□3-Δ	D3V-6G3-2□3-Δ	D3V-6G3-3□3-Δ
	M		D3V-6G3M-1□3-Δ	D3V-6G3M-2□3-Δ	D3V-6G3M-3□3-Δ
Simulated roller lever 	Internal	0.29N {30gf}	D3V-6G4-1□3-Δ	D3V-6G4-2□3-Δ	D3V-6G4-3□3-Δ
	M		D3V-6G4M-1□3-Δ	D3V-6G4M-2□3-Δ	D3V-6G4M-3□3-Δ
Short hinge roller lever 	Internal	0.59N {60gf}	D3V-6G5-1□3-Δ	D3V-6G5-2□3-Δ	D3V-6G5-3□3-Δ
	M		D3V-6G5M-1□3-Δ	D3V-6G5M-2□3-Δ	D3V-6G5M-3□3-Δ
Hinge roller lever 	Internal	0.29N {30gf}	D3V-6G6-1□3-Δ	D3V-6G6-2□3-Δ	D3V-6G6-3□3-Δ
	M		D3V-6G6M-1□3-Δ	D3V-6G6M-2□3-Δ	D3V-6G6M-3□3-Δ

Note: The □ in the model number is for the terminal code.

A: Solder terminals

C2: Quick-connect terminals (#187)







C: Quick-connect terminals (#250)

The Δ in the model number is for the mounting hole size.

None: 3.1 mm

K: 2.9 mm

- 0.1 A (OF: 0.49 N {50 gf})

Actuator	Hinge position	Maximum Operating Force (OF)	Contact form		
			SPDT	SPST-NC	SPST-NO
Pin plunger 	---	0.49N {50gf}	D3V-01-1□3-Δ	D3V-01-2□3-Δ	D3V-01-3□3-Δ
Short hinge lever 	Internal	0.49N {50gf}	D3V-011-1□3-Δ	D3V-011-2□3-Δ	D3V-011-3□3-Δ
	M		D3V-011M-1□3-Δ	D3V-011M-2□3-Δ	D3V-011M-3□3-Δ
Hinge lever 	Internal	0.29N {30gf}	D3V-012-1□3-Δ	D3V-012-2□3-Δ	D3V-012-3□3-Δ
	M		D3V-012M-1□3-Δ	D3V-012M-2□3-Δ	D3V-012M-3□3-Δ
Long hinge lever 	Internal	0.20N {20gf}	D3V-013-1□3-Δ	D3V-013-2□3-Δ	D3V-013-3□3-Δ
	M		D3V-013M-1□3-Δ	D3V-013M-2□3-Δ	D3V-013M-3□3-Δ
Simulated roller lever 	Internal	0.29N {30gf}	D3V-014-1□3-Δ	D3V-014-2□3-Δ	D3V-014-3□3-Δ
	M		D3V-014M-1□3-Δ	D3V-014M-2□3-Δ	D3V-014M-3□3-Δ
Short hinge roller lever 	Internal	0.59N {60gf}	D3V-015-1□3-Δ	D3V-015-2□3-Δ	D3V-015-3□3-Δ
	M		D3V-015M-1□3-Δ	D3V-015M-2□3-Δ	D3V-015M-3□3-Δ
Hinge roller lever 	Internal	0.29N {30gf}	D3V-016-1□3-Δ	D3V-016-2□3-Δ	D3V-016-3□3-Δ
	M		D3V-016M-1□3-Δ	D3V-016M-2□3-Δ	D3V-016M-3□3-Δ

- 0.1 A (OF: 0.25 N {25 gf})

Actuator	Hinge position	Maximum Operating Force (OF)	Contact form		
			SPDT	SPST-NC	SPST-NO
Pin plunger 	---	0.25N {25gf}	D3V-01-1□2-Δ	D3V-01-2□2-Δ	D3V-01-3□2-Δ

Note: The □ in the model number is for the terminal code.

A: Solder terminals

C2: Quick-connect terminals (#187)

C: Quick-connect terminals (#250)

The Δ in the model number is for the mounting hole size.

None: 3.1 mm

K: 2.9 mm

Specifications

Ratings

Model	Rated voltage	Resistive load
D3V-21	250 VAC	21 A
	125 VDC	0.6 A
	250 VDC	0.3 A
D3V-16	250 VAC	16 A
	125 VDC	0.6 A
	250 VDC	0.3 A
D3V-11	250 VAC	11 A
	125 VDC	0.6 A
	250 VDC	0.3 A
D3V-6	250 VAC	6 A
	125 VDC	0.4 A
	250 VDC	0.3 A
D3V-01	125 VAC	0.1 A
	30 VDC	0.1 A

- Note:**
1. The above current values are the normal current values of models with a contact gap of 1 mm (gap F), which vary with the normal current values of models with a contact gap of 0.5 mm (gap G).
 2. The ratings values apply under the following test conditions:
Ambient temperature: 20±2°C
Ambient humidity: 65±5%
Operating frequency: 30 operations/min

Characteristics

Permissible operating speed	0.1 mm to 1 m/s (pin plunger models)
Permissible operating frequency	Mechanical: 600 operations/min max. Electrical: 30 operations/min max.
Insulation resistance	100 MΩ min. (at 500 VDC)
Contact resistance (initial values)	D3V-21: 50 mΩ max. D3V-16, D3V-11, D3V-6: 30 mΩ max. D3V-01, 0.49 N {50 gf}: 50 mΩ max. 0.25 N {25 gf}: 100 mΩ max.
Dielectric strength (see note 2)	1,000 VAC, 50/60 Hz for 1 min between terminals of the same polarity 2,000 VAC, 50/60 Hz for 1 min between current-carrying metal parts and ground, and between each terminal and non-current-carrying metal parts
Vibration resistance (see note 3)	Malfunction: 10 to 55 Hz, 1.5-mm double amplitude
Shock resistance (see note 3)	Destruction: 400 m/s ² {approx. 40G} max. Malfunction: 100 m/s ² {approx. 10G} max.
Durability (see note 4)	Mechanical: 10,000,000 operations min. Electrical: D3V-21: 50,000 operations min. D3V-16: 100,000 operations min. D3V-11: 200,000 operations min. D3V-6, D3V-01: 500,000 operations min.
Degree of protection	IEC IP40
Degree of protection against electric shock	Class I
Proof tracking index (PTI)	250
Ambient operating temperature	D3V-21, D3V-01: -25°C to +85°C (at ambient humidity of 60% max.) (with no icing or condensation) D3V-16, D3V-11, D3V-6: -25°C to +105°C (at ambient humidity of 60% max.) (with no icing or condensation)
Ambient operating humidity	85% max. (for 5°C to 35°C)
Weight	Approx. 6.2 g (pin plunger models)

- Note:**
1. The data given above are initial values.
 2. The dielectric strength values shown in the table are for models with a Separator.
 3. For the pin plunger models, the above values apply for use at both the free position and total travel position. For the lever models, they apply at the total travel position.
 4. For testing conditions, contact your OMRON sales representative.

Approved Standards

Consult your OMRON sales representative for specific models with standard approvals.

UL1054 (File No. E41515)/CSA C22.2 No.55 (File No. LR21642)

Rated voltage	D3V-21G	D3V-16	D3V-16G	D3V-11	D3V-11G	D3V-6	D3V-6G	D3V-01
125 VAC	---	16 A, 1/2 HP	16 A, 1/2 HP	11 A, 1/2 HP	11 A, 1/2 HP	6 A, 1/4 HP	6 A, 1/4 HP	0.1 A
250 VAC	20.1 A	16 A, 1/2 HP	16 A, 1/2 HP	11 A, 1/2 HP	11 A, 1/2 HP	6 A, 1/4 HP	6 A, 1/4 HP	---
125 VDC	---	0.6 A	0.1 A	0.6 A	0.1 A	---	---	---
250 VDC	---	0.3 A	---	0.3 A	---	---	---	---

EN 61058-1: 1992+A1: 1993 (License No. 40024894)

Rated voltage	D3V-21G	D3V-16	D3V-11	D3V-6	D3V-01
125 VAC	---	---	---	---	0.1 A
250 VAC	20 (4) A	16 (3) A	11 (3) A	6 (2) A	---

Testing conditions: 5E4 (50,000 operations), T85 (0°C to 85°C) for D3V-21/D3V-01, T105 (0°C to 105°C) for D3V-16/D3V-11/D3V-6

Rated voltage	D3V-21G
250 VAC	21 (8) A

Testing conditions: 10,000 operations, T85 (0°C to 85°C)

Contact Specifications

Item		D3V-21	D3V-16	D3V-11	D3V-6	D3V-01
Contact	Specification	Rivet				Crossbar
	Material	Silver alloy				Gold alloy
	Gap (standard value)	0.5 mm	1 mm (F gap type) or 0.5 mm (G gap type)		1.0 mm	
Inrush current	NC	50 A max.	40 A max.	24 A max.	15 A max.	---
	NO					
Minimum applicable load (see note)		160 mA at 5 VDC				1 mA at 5 VDC

Note: For more information on the minimum applicable load, refer to *Using Micro Loads* on page 17.

Contact Form

SPDT

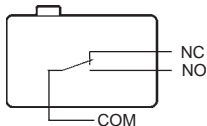

SPST-NC

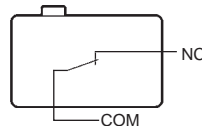

SPST-NO

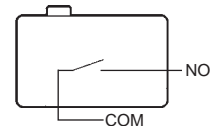

Dimensions

Terminals

Note: 1. All units are in millimeters unless otherwise indicated.

2. The table below is for the SPDT contact specifications. Two terminals will be available for SPST-NO or SPST-NC contact specifications. For terminal positions, refer to the above *Contact Form*.

Solder Terminals(A)	Quick-connect Terminals (#187) (C2)	Quick-connect Terminals (#250) (C)
<p>Three, solder terminals</p>	<p>Three, quick-connect terminals (#187)</p>	<p>Three, quick-connect terminals (#250)</p>
<p>Note: Indicates the length to the center of the 1.6-dia. holes</p>	<p>1.6-dia. terminal hole</p>	<p>1.65-dia. terminal hole</p>

Mounting Holes

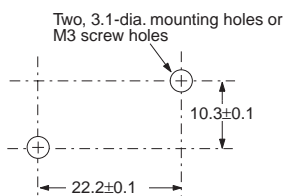

Dimensions and Operating Characteristics

- Note:**
1. All units are in millimeters unless otherwise indicated.
 2. Unless otherwise specified, a tolerance of ± 0.4 mm applies to all dimensions.
 3. The following illustrations and drawings are for quick-connect terminals (#187) (terminals C2). D3V models incorporate terminals A and C. These models are different from #187 models in terminal size only. Terminals A and C are omitted from the following drawings. Refer to *Terminals* on page 9 for these terminals.
 4. The □ in the model number is for the terminal code.
 5. The Δ in the model number is for the mounting hole size.
The hole size in the following illustrations of models with a suffix "K" in the Δ is 2.9 mm.
 6. The operating characteristics are for operation in the A direction (↓).

Pin Plunger Models

- D3V-21G-1□4A-Δ
- D3V-16-1□5-Δ
- D3V-11-1□5-Δ
- D3V-11-1□4-Δ
- D3V-6-1□4-Δ
- D3V-6G-1□3-Δ
- D3V-01-1□2-Δ
- D3V-01-1□3-Δ

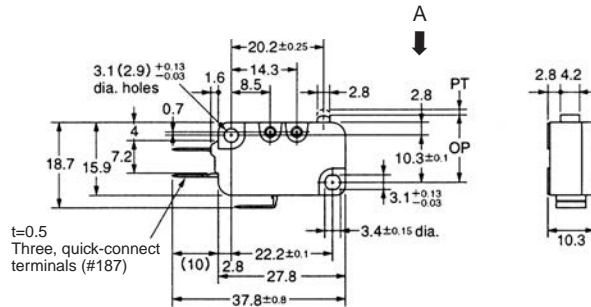

Model	D3V-21G-1□4A-Δ	D3V-16-1□5-Δ D3V-11-1□5-Δ	D3V-11-1□4-Δ D3V-6-1□4-Δ	D3V-6G-1□3-Δ	D3V-01-1□3-Δ	D3V-01-1□2-Δ
OF max.	1.23 N {125 gf}	1.96 N {200 gf}	0.98 N {100 gf}	0.49 N {50 gf}	0.49 N {50 gf}	0.25 N {25 gf}
RF min.	0.20 N {20 gf}	0.49 N {50 gf}	0.15 N {15 gf}	0.05 N {5 gf}	0.05 N {5 gf}	0.03 N {3 gf}
PT max.	1.2 mm	1.2 mm			1.2 mm	
OT min.	1.0 mm	1.0 mm			1.0 mm	
MD max.	0.3 mm	0.4 mm (F gap type) or 0.3 mm (G gap type)			0.4 mm	
OP	14.7±0.4 mm					

Short Hinge Lever Models

- D3V-21G1-1□4A-Δ
- D3V-161-1□5-Δ
- D3V-111-1□5-Δ
- D3V-111-1□4-Δ
- D3V-61-1□4-Δ
- D3V-6G1-1□3-Δ
- D3V-011-1□3-Δ

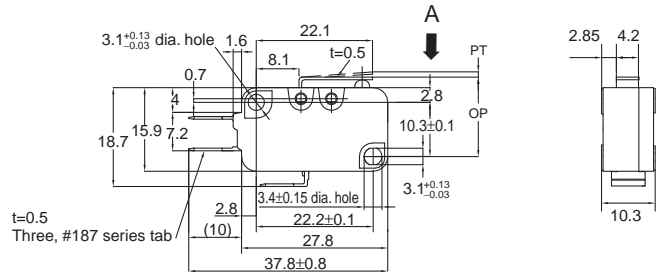
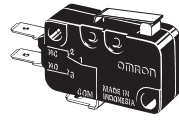

Model	D3V-21G1-1□4A-Δ	D3V-161-1□5-Δ D3V-111-1□5-Δ	D3V-111-1□4-Δ D3V-61-1□4-Δ	D3V-6G1-1□3-Δ	D3V-011-1□3-Δ
OF max.	1.23 N {125 gf}	1.96 N {200 gf}	0.98 N {100 gf}	0.49 N {50 gf}	
RF min.	0.20 N {20 gf}	0.49 N {50 gf}	0.15 N {15 gf}	0.05 N {5 gf}	
PT max.	1.6 mm	1.6 mm			1.6 mm
OT min.	0.8 mm	0.8 mm			0.8 mm
MD max.	0.5 mm	0.6 mm (F gap type) or 0.5 mm (G gap type)			0.6 mm
OP	15.2±0.5 mm				

- D3V-21G1M-1□4A-Δ
- D3V-161M-1□5-Δ
- D3V-111M-1□5-Δ
- D3V-111M-1□4-Δ
- D3V-61M-1□4-Δ
- D3V-6G1M-1□3-Δ
- D3V-011M-1□3-Δ

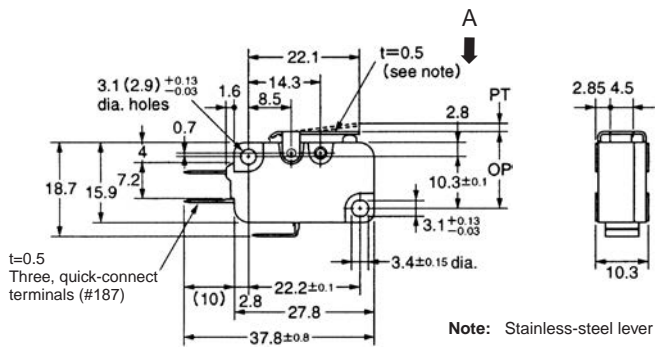
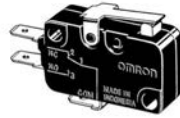

Model	D3V-21G1M-1□4A-Δ	D3V-161M-1□5-Δ D3V-111M-1□5-Δ	D3V-111M-1□4-Δ D3V-61M-1□4-Δ	D3V-6G1M-1□3-Δ	D3V-011M-1□3-Δ
OF max.	1.23 N {125 gf}	1.96 N {200 gf}	0.98 N {100 gf}	0.49 N {50 gf}	
RF min.	0.20 N {20 gf}	0.49 N {50 gf}	0.15 N {15 gf}	0.05 N {5 gf}	
PT max.	1.6 mm	1.6 mm			1.6 mm
OT min.	0.8 mm	0.8 mm			0.8 mm
MD max.	0.5 mm	0.6 mm (F gap type) or 0.5 mm (G gap type)			0.6 mm
OP	15.2±0.5 mm				

- D3V-21G1K-1□4A-Δ
- D3V-161K-1□5-Δ
- D3V-111K-1□5-Δ
- D3V-111K-1□4-Δ
- D3V-61K-1□4-Δ
- D3V-6G1K-1□3-Δ
- D3V-011K-1□3-Δ

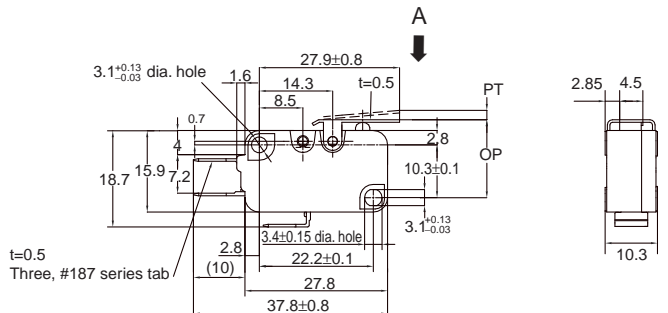
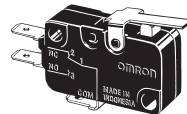

Model	D3V-21G1K-1□4A-Δ	D3V-161K-1□5-Δ D3V-111K-1□5-Δ	D3V-111K-1□4-Δ D3V-61K-1□4-Δ	D3V-6G1K-1□3-Δ	D3V-011K-1□3-Δ
OF max.	0.83 N {85 gf}	1.27 N {130 gf}	0.64 N {65 gf}	0.34 N {35 gf}	
RF min.	0.08 N {8 gf}	0.16 N {16 gf}	0.08 N {8 gf}	0.04 N {4 gf}	
PT max.	3.5 mm	3.5 mm			3.5 mm
OT min.	1.1 mm	1.1 mm			1.1 mm
MD max.	1.1 mm	1.2 mm (F gap type) or 1.1 mm (G gap type)			1.2 mm
OP	15.2±1.2 mm				

Hinge Lever Models

- D3V-21G2-1□4A-Δ
- D3V-162-1□5-Δ
- D3V-112-1□5-Δ
- D3V-112-1□4-Δ
- D3V-62-1□4-Δ
- D3V-6G2-1□3-Δ
- D3V-012-1□3-Δ

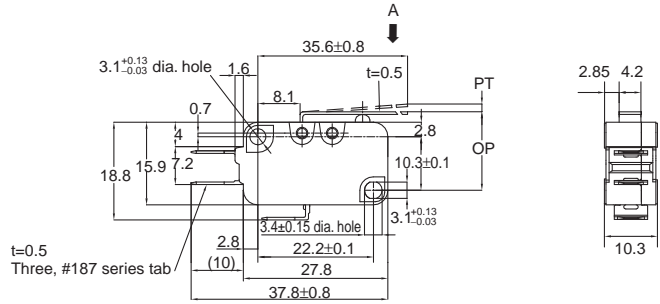
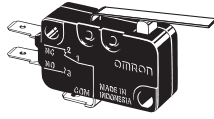

Model	D3V-21G2-1□4A-Δ	D3V-162-1□5-Δ D3V-112-1□5-Δ	D3V-112-1□4-Δ D3V-62-1□4-Δ	D3V-6G2-1□3-Δ	D3V-012-1□3-Δ
OF max.	0.78 N {80 gf}	1.23 N {125 gf}	0.59 N {60 gf}		0.29 N {30 gf}
RF min.	0.06 N {6 gf}	0.14 N {14 gf}	0.06 N {6 gf}		---
PT max.	4.0 mm	4.0 mm			4.0 mm
OT min.	1.6 mm	1.6 mm			1.6 mm
MD max.	0.8 mm	1.5 mm (F gap type) or 0.8 mm (G gap type)			1.5 mm
OP	15.2±1.2 mm				

- D3V-21G2M-1□4A-Δ
- D3V-162M-1□5-Δ
- D3V-112M-1□5-Δ
- D3V-112M-1□4-Δ
- D3V-62M-1□4-Δ
- D3V-6G2M-1□3-Δ
- D3V-012M-1□3-Δ

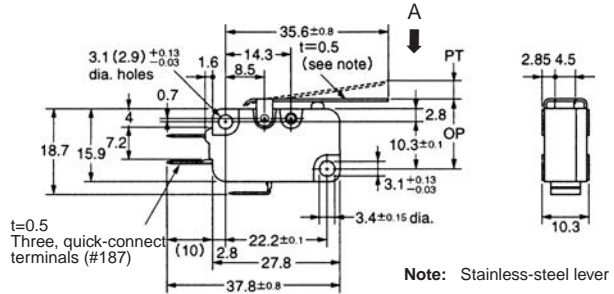

Model	D3V-21G2M-1□4A-Δ	D3V-162M-1□5-Δ D3V-112M-1□5-Δ	D3V-112M-1□4-Δ D3V-62M-1□4-Δ	D3V-6G2M-1□3-Δ	D3V-012M-1□3-Δ
OF max.	0.78 N {80 gf}	1.23 N {125 gf}	0.59 N {60 gf}		0.29 N {30 gf}
RF min.	0.06 N {6 gf}	0.14 N {14 gf}	0.06 N {6 gf}		---
PT max.	4.0 mm	4.0 mm			4.0 mm
OT min.	1.6 mm	1.6 mm			1.6 mm
MD max.	0.8 mm	1.5 mm (F gap type) or 0.8 mm (G gap type)			1.5 mm
OP	15.2±1.2 mm				

- D3V-21G2K-1□4A-Δ
- D3V-162K-1□5-Δ
- D3V-112K-1□5-Δ
- D3V-112K-1□4-Δ
- D3V-62K-1□4-Δ
- D3V-6G2K-1□3-Δ
- D3V-012K-1□3-Δ

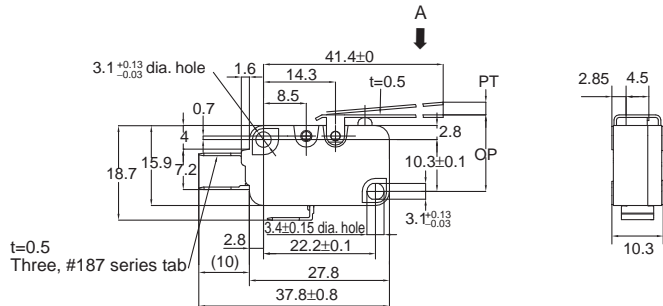
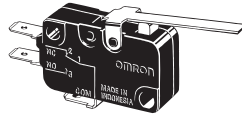

Model	D3V-21G2K-1□4A-Δ	D3V-162K-1□5-Δ D3V-112K-1□5-Δ	D3V-112K-1□4-Δ D3V-62K-1□4-Δ	D3V-6G2K-1□3-Δ	D3V-012K-1□3-Δ
OF max.	0.44 N {45 gf}	0.69 N {70 gf}	0.34 N {35 gf}	0.20 N {20 gf}	
RF min.	0.04 N {4 gf}	0.08 N {8 gf}	0.04 N {4 gf}	---	
PT max.	6.0 mm	6.0 mm			6.0 mm
OT min.	2.5 mm	2.5 mm			2.5 mm
MD max.	1.3 mm	2.0 mm (F gap type) or 1.3 mm (G gap type)			2.0 mm
OP	15.2±2.0 mm				

Long Hinge Lever Models

- D3V-21G3-1□4A-Δ
- D3V-163-1□5-Δ
- D3V-113-1□5-Δ
- D3V-113-1□4-Δ
- D3V-63-1□4-Δ
- D3V-6G3-1□3-Δ
- D3V-013-1□3-Δ

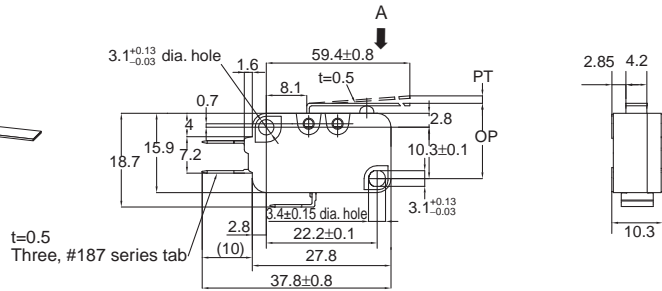

Model	D3V-21G3-1□4A-Δ	D3V-163-1□5-Δ D3V-113-1□5-Δ	D3V-113-1□4-Δ D3V-63-1□4-Δ	D3V-6G3-1□3-Δ	D3V-013-1□3-Δ
OF max.	0.44 N {45 gf}	0.69 N {70 gf}	0.34 N {35 gf}	0.20 N {20 gf}	
RF min.	0.03 N {3 gf}	0.06 N {6 gf}	---	---	
PT max.	9.0 mm	9.0 mm	9.0 mm	9.0 mm	
OT min.	2.0 mm	2.0 mm	3.2 mm	3.2 mm	
MD max.	2.0 mm	2.8 mm (F gap type) or 2.0 mm (G gap type)	2.8 mm (F gap type) or 2.0 mm (G gap type)	2.8 mm	
OP	15.2 ^{+2.6} _{-3.2} mm		15.2±2.6 mm		

- D3V-21G3M-1□4A-Δ
- D3V-163M-1□5-Δ
- D3V-113M-1□5-Δ
- D3V-113M-1□4-Δ
- D3V-63M-1□4-Δ
- D3V-6G3M-1□3-Δ
- D3V-013M-1□3-Δ

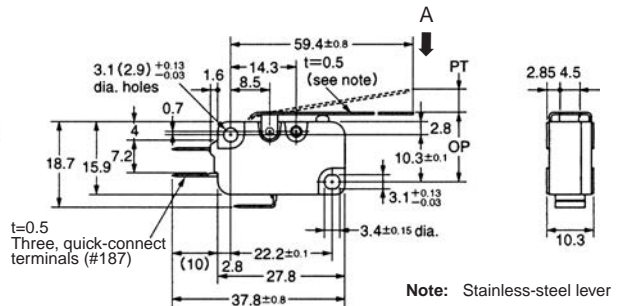

Model	D3V-21G3M-1□4A-Δ	D3V-163M-1□5-Δ D3V-113M-1□5-Δ	D3V-113M-1□4-Δ D3V-63M-1□4-Δ	D3V-6G3M-1□3-Δ	D3V-013M-1□3-Δ
OF max.	0.44 N {45 gf}	0.69 N {70 gf}	0.34 N {35 gf}	0.20 N {20 gf}	
RF min.	0.03 N {3 gf}	0.06 N {6 gf}	---	---	
PT max.	9.0 mm	9.0 mm	9.0 mm	9.0 mm	
OT min.	2.0 mm	2.0 mm	3.2 mm	3.2 mm	
MD max.	2.0 mm	2.8 mm (F gap type) or 2.0 mm (G gap type)	2.8 mm (F gap type) or 2.0 mm (G gap type)	2.8 mm	
OP	15.2 ^{+2.6} _{-3.2} mm		15.2±2.6 mm		

- D3V-21G3K-1□4A-Δ
- D3V-163K-1□5-Δ
- D3V-113K-1□5-Δ
- D3V-113K-1□4-Δ
- D3V-63K-1□4-Δ
- D3V-6G3K-1□3-Δ
- D3V-013K-1□3-Δ

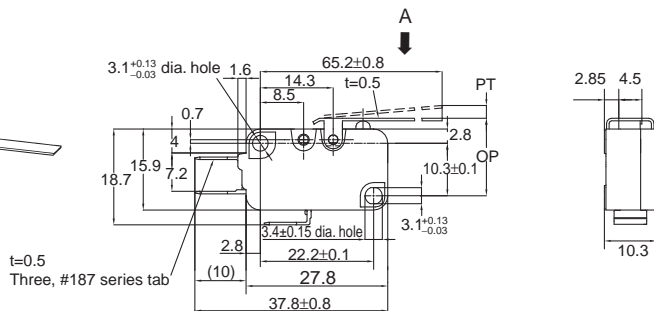
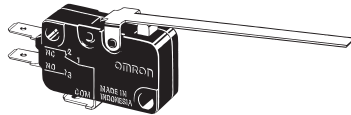

Model	D3V-21G3K-1□4A-Δ	D3V-163K-1□5-Δ D3V-113K-1□5-Δ	D3V-113K-1□4-Δ D3V-63K-1□4-Δ	D3V-6G3K-1□3-Δ	D3V-013K-1□3-Δ
OF max.	0.20 N {20 gf}	0.34 N {35 gf}	0.20 N {20 gf}	0.10 N {10 gf}	
RF min.	---	0.04 N {4 gf}	---	---	
PT max.	15.0 mm	15.0 mm	---	15.0 mm	
OT min.	4.0 mm	4.0 mm	---	4.0 mm	
MD max.	3.0 mm	3.8 mm (F gap type) or 3.0 mm (G gap type)	---	3.8 mm	
OP	15.2±3.0 mm				

Simulated Roller Lever Models

- D3V-21G4-1□4A-Δ
- D3V-164-1□5-Δ
- D3V-114-1□5-Δ
- D3V-114-1□4-Δ
- D3V-64-1□4-Δ
- D3V-6G4-1□3-Δ
- D3V-014-1□3-Δ

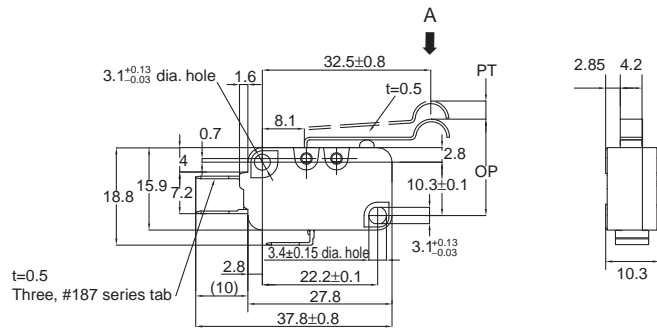
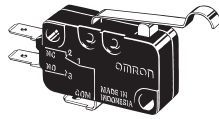

Model	D3V-21G4-1□4A-Δ	D3V-164-1□5-Δ D3V-114-1□5-Δ	D3V-114-1□4-Δ D3V-64-1□4-Δ	D3V-6G4-1□3-Δ	D3V-014-1□3-Δ
OF max.	0.83 N {85 gf}	1.23 N {125 gf}	0.59 N {60 gf}	0.29 N {30 gf}	
RF min.	0.07 N {7 gf}	0.14 N {14 gf}	0.06 N {6 gf}	---	
PT max.	4.0 mm	4.0 mm			4.0 mm
OT min.	1.6 mm	1.6 mm			1.6 mm
MD max.	1.4 mm	1.5 mm (F gap type) or 0.8 mm (G gap type)			1.5 mm
OP	18.7±1.2 mm				

- D3V-21G4M-1□4A-Δ
- D3V-164M-1□5-Δ
- D3V-114M-1□5-Δ
- D3V-114M-1□4-Δ
- D3V-64M-1□4-Δ
- D3V-6G4M-1□3-Δ
- D3V-014M-1□3-Δ

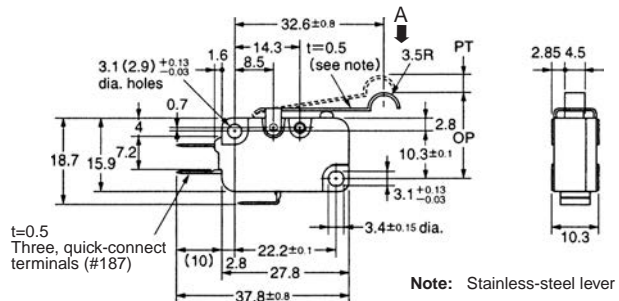

Model	D3V-21G4M-1□4A-Δ	D3V-164M-1□5-Δ D3V-114M-1□5-Δ	D3V-114M-1□4-Δ D3V-64M-1□4-Δ	D3V-6G4M-1□3-Δ	D3V-014M-1□3-Δ
OF max.	0.83 N {85 gf}	1.23 N {125 gf}	0.59 N {60 gf}	0.29 N {30 gf}	
RF min.	0.07 N {7 gf}	0.14 N {14 gf}	0.06 N {6 gf}	---	
PT max.	4.0 mm	4.0 mm			4.0 mm
OT min.	1.6 mm	1.6 mm			1.6 mm
MD max.	1.4 mm	1.5 mm (F gap type) or 0.8 mm (G gap type)			1.5 mm
OP	18.7±1.2 mm				

- D3V-21G4K-1□4A-Δ
- D3V-164K-1□5-Δ
- D3V-114K-1□5-Δ
- D3V-114K-1□4-Δ
- D3V-64K-1□4-Δ
- D3V-6G4K-1□3-Δ
- D3V-014K-1□3-Δ

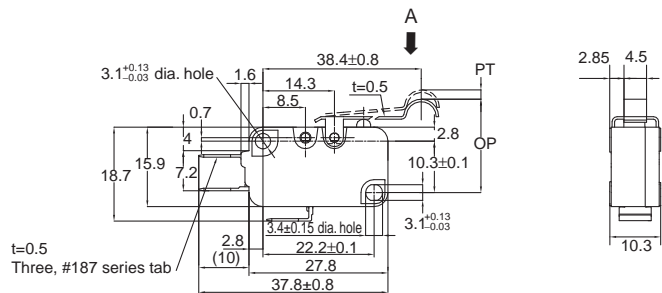

Model	D3V-21G4K-1□4A-Δ	D3V-164K-1□5-Δ D3V-114K-1□5-Δ	D3V-114K-1□4-Δ D3V-64K-1□4-Δ	D3V-6G4K-1□3-Δ	D3V-014K-1□3-Δ
OF max.	0.54 N {55 gf}	0.74 N {75 gf}	0.39 N {40 gf}	0.20 N {20 gf}	
RF min.	0.03 N {3 gf}	0.10 N {10 gf}	0.03 N {3 gf}	---	
PT max.	8.0 mm	8.0 mm			8.0 mm
OT min.	1.5 mm	1.5 mm			1.5 mm
MD max.	3.0 mm	3.5 mm (F gap type) or 3.0 mm (G gap type)			3.5 mm
OP	18.7±2.0 mm				

Short Hinge Roller Lever Models

- D3V-21G5-1□4A-Δ
- D3V-165-1□5-Δ
- D3V-115-1□5-Δ
- D3V-115-1□4-Δ
- D3V-65-1□4-Δ
- D3V-6G5-1□3-Δ
- D3V-015-1□3-Δ

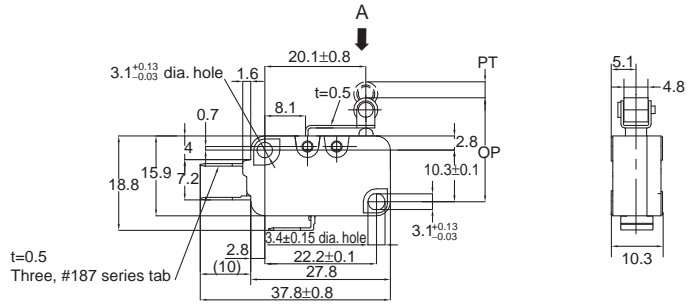
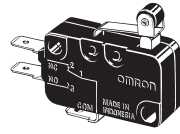

Model	D3V-21G5-1□4A-Δ	D3V-165-1□5-Δ D3V-115-1□5-Δ	D3V-115-1□4-Δ D3V-65-1□4-Δ	D3V-6G5-1□3-Δ	D3V-015-1□3-Δ
OF max.	1.42 N {145 gf}	2.35 N {240 gf}	1.18 N {120 gf}	0.59 N {60 gf}	
RF min.	0.2 N {20 gf}	0.49 N {50 gf}	0.15 N {15 gf}	0.06 N {6 gf}	
PT max.	1.6 mm	1.6 mm			1.6 mm
OT min.	0.8 mm	0.8 mm			0.8 mm
MD max.	0.5 mm	0.6 mm (F gap type) or 0.5 mm (G gap type)			0.6 mm
OP	20.7±0.6 mm				

- D3V-21G5M-1□4A-Δ
- D3V-165M-1□5-Δ
- D3V-115M-1□5-Δ
- D3V-115M-1□4-Δ
- D3V-65M-1□4-Δ
- D3V-6G5M-1□3-Δ
- D3V-015M-1□3-Δ

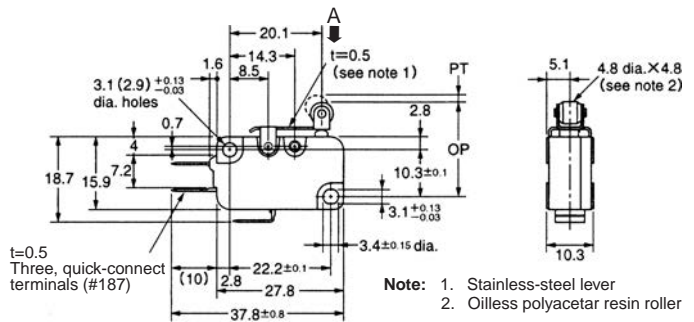
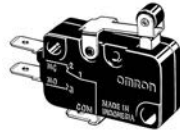

Note: 1. Stainless-steel lever
2. Oilless polyacetal resin roller

Model	D3V-21G5M-1□4A-Δ	D3V-165M-1□5-Δ D3V-115M-1□5-Δ	D3V-115M-1□4-Δ D3V-65M-1□4-Δ	D3V-6G5M-1□3-Δ	D3V-015M-1□3-Δ
OF max.	1.42 N {145 gf}	2.35 N {240 gf}	1.18 N {120 gf}	0.59 N {60 gf}	
RF min.	0.2 N {20 gf}	0.49 N {50 gf}	0.15 N {15 gf}	0.06 N {6 gf}	
PT max.	1.6 mm	1.6 mm			1.6 mm
OT min.	0.8 mm	0.8 mm			0.8 mm
MD max.	0.5 mm	0.6 mm (F gap type) or 0.5 mm (G gap type)			0.6 mm
OP	20.7±0.6 mm				

- D3V-21G5K-1□4A-Δ
- D3V-165K-1□5-Δ
- D3V-115K-1□5-Δ
- D3V-115K-1□4-Δ
- D3V-65K-1□4-Δ
- D3V-6G5K-1□3-Δ
- D3V-015K-1□3-Δ

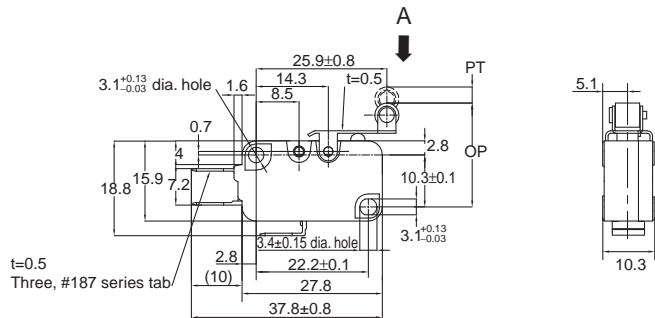
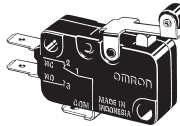

Model	D3V-21G5K-1□4A-Δ	D3V-165K-1□5-Δ D3V-115K-1□5-Δ	D3V-115K-1□4-Δ D3V-65K-1□4-Δ	D3V-6G5K-1□3-Δ	D3V-015K-1□3-Δ
OF max.	0.98 N {100 gf}	1.57 N {160 gf}	0.78 N {80 gf}	0.39 N {40 gf}	
RF min.	0.08 N {8 gf}	0.15 N {15 gf}	0.08 N {8 gf}	0.04 N {4 gf}	
PT max.	2.6 mm	2.6 mm			2.6 mm
OT min.	1.0 mm	1.0 mm			1.0 mm
MD max.	0.8 mm	0.9 mm (F gap type) or 0.8 mm (G gap type)			0.9 mm
OP	20.7±1.0 mm				

Hinge Roller Lever Models

- D3V-21G6-1□4A-Δ
- D3V-166-1□5-Δ
- D3V-116-1□5-Δ
- D3V-116-1□4-Δ
- D3V-66-1□4-Δ
- D3V-6G6-1□3-Δ
- D3V-016-1□3-Δ

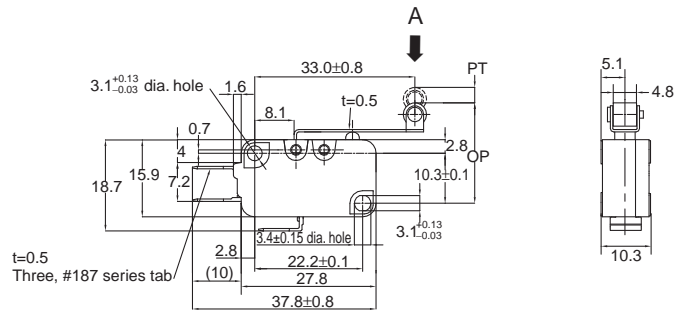
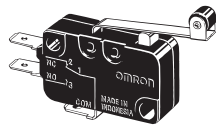

Model	D3V-21G6-1□4A-Δ	D3V-166-1□5-Δ D3V-116-1□5-Δ	D3V-116-1□4-Δ D3V-66-1□4-Δ	D3V-6G6-1□3-Δ	D3V-016-1□3-Δ
OF max.	0.79 N {80 gf}	1.23 N {125 gf}	0.59 N {60 gf}	0.29 N {30 gf}	
RF min.	0.05 N {5 gf}	0.14 N {14 gf}	0.06 N {6 gf}	---	
PT max.	4.0 mm	4.0 mm			4.0 mm
OT min.	1.6 mm	1.6 mm			1.6 mm
MD max.	0.8 mm	1.5 mm (F gap type) or 0.8 mm (G gap type)			1.5 mm
OP	20.7±1.2 mm				

- D3V-21G6M-1□4A-Δ
- D3V-166M-1□5-Δ
- D3V-116M-1□5-Δ
- D3V-116M-1□4-Δ
- D3V-66M-1□4-Δ
- D3V-6G6M-1□3-Δ
- D3V-016M-1□3-Δ

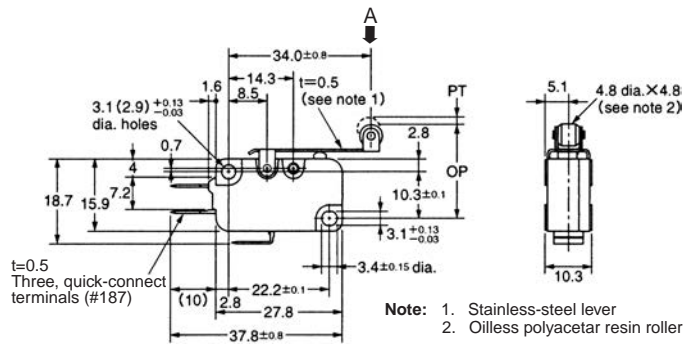

Model	D3V-21G6M-1□4A-Δ	D3V-166M-1□5-Δ D3V-116M-1□5-Δ	D3V-116M-1□4-Δ D3V-66M-1□4-Δ	D3V-6G6M-1□3-Δ	D3V-016M-1□3-Δ
OF max.	0.79 N {80 gf}	1.23 N {125 gf}	0.59 N {60 gf}	0.29 N {30 gf}	
RF min.	0.05 N {5 gf}	0.14 N {14 gf}	0.06 N {6 gf}	---	
PT max.	4.0 mm	4.0 mm			4.0 mm
OT min.	1.6 mm	1.6 mm			1.6 mm
MD max.	0.8 mm	1.5 mm (F gap type) or 0.8 mm (G gap type)			1.5 mm
OP	20.7±1.2 mm				

- D3V-21G6K-1□4A-Δ
- D3V-166K-1□5-Δ
- D3V-116K-1□5-Δ
- D3V-116K-1□4-Δ
- D3V-66K-1□4-Δ
- D3V-6G6K-1□3-Δ
- D3V-016K-1□3-Δ

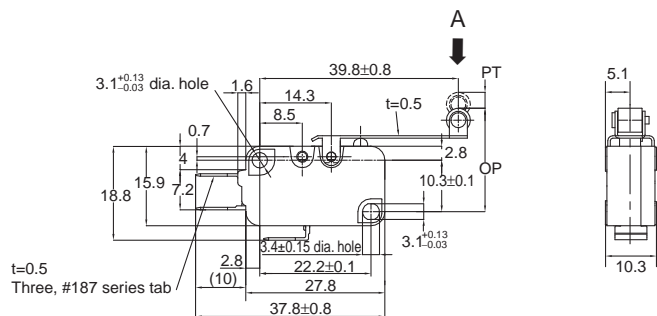
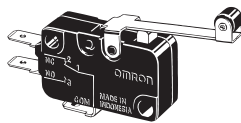

Model	D3V-21G6K-1□4A-Δ	D3V-166K-1□5-Δ D3V-116K-1□5-Δ	D3V-116K-1□4-Δ D3V-66K-1□4-Δ	D3V-6G6K-1□3-Δ	D3V-016K-1□3-Δ
OF max.	0.49 N {50 gf}	0.74 N {75 gf}	0.39 N {40 gf}	0.20 N {20 gf}	
RF min.	0.03 N {3 gf}	0.10 N {10 gf}	0.03 N {3 gf}	---	
PT max.	7.2 mm	7.2 mm			7.2 mm
OT min.	2.0 mm	2.0 mm			2.0 mm
MD max.	2.0 mm	2.7 mm (F gap type) or 2.0 mm (G gap type)			2.7 mm
OP	20.7±2.2 mm				

Precautions

Refer to *General Information*.

Cautions

Handling

Be careful not to drop the switch. Doing so may cause damage to the switch's internal components because it is designed for a small load.

Correct Use

Mounting

Use two M3 mounting screws with an appropriate screwdriver to mount the switch. Tighten the screws to a torque of 0.39 to 0.59 N • m {4 to 6 kgf • cm}.

Mounting Direction

Mount lever-operated switches with a maximum operating force of 0.49 N in a direction where the actuator weight will not be applied to the switch. Since the switch is designed for a small load, its resetting force is small. Therefore, resetting failure may occur if unnecessary load is applied to the switch.

Insulation Distance

According to EN61058-1, the minimum insulation thickness for this switch should be 1.1 mm and minimum clearance distance between the terminal and mounting plate should be 1.9 mm. If the insulation distance cannot be provided in the product incorporating the switch, either use a switch with insulation barrier or use a Separator to ensure sufficient insulation distance.

Using Micro Loads

Using a model for ordinary loads to open or close the contact of a micro load circuit may result faulty contact. Use models that operate in the following range. However, even when using micro load models within the operating range shown below, if inrush current occurs when the contact is opened or closed, it may increase contact wear and so decrease durability. Therefore, insert a contact protection circuit where necessary.

The minimum applicable load is the N-level reference value. This value indicates the malfunction reference level for the reliability level of 60% ($\lambda 60$). The equation, $\lambda 60 = 0.5 \times 10^{-6}/\text{operations}$ indicates that the estimated malfunction rate is less than 1/2,000,000 operations with a reliability level of 60%.

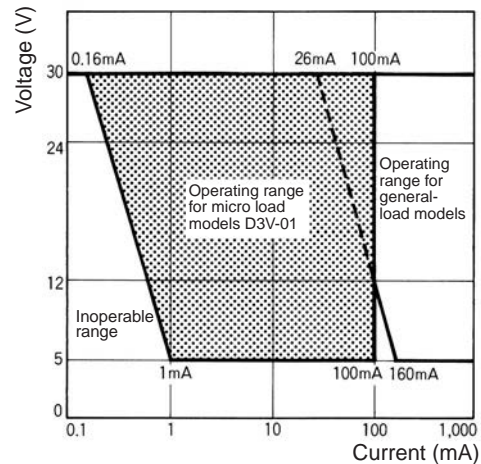

Solder Terminal Approval Conditions

Soldering iron can be used.
Soldering hook hole available.
Soldering terminal types 1 and 2 are met.

Actuator (Sold Separately)

Various Actuators are available as shown on D3V/V/VX/D2MV/D2RV Common Accessories.

Connector (Sold Separately)

Refer to Terminal Connectors.

- Application examples provided in this document are for reference only. In actual applications, confirm equipment functions and safety before using the product.
- Consult your OMRON representative before using the product under conditions which are not described in the manual or applying the product to nuclear control systems, railroad systems, aviation systems, vehicles, combustion systems, medical equipment, amusement machines, safety equipment, and other systems or equipment that may have a serious influence on lives and property if used improperly. Make sure that the ratings and performance characteristics of the product provide a margin of safety for the system or equipment, and be sure to provide the system or equipment with double safety mechanisms.

Note: Do not use this document to operate the Unit.

OMRON Corporation

ELECTRONIC AND MECHANICAL COMPONENTS COMPANY

Contact: www.omron.com/ecb

Cat. No. B103-E1-04
0812(0207)(O)