

V_{DSS}	600V
$R_{DS(on)}(Max.)$	0.196Ω
I_D	±20A
P_D	68W

●Features

- 1) Low on-resistance.
- 2) Ultra fast switching speed.
- 3) Parallel use is easy.
- 4) Pb-free lead plating ; RoHS compliant

●Application

Switching

●Outline

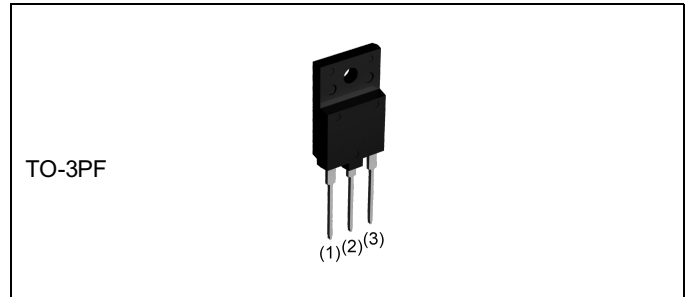

●Inner circuit

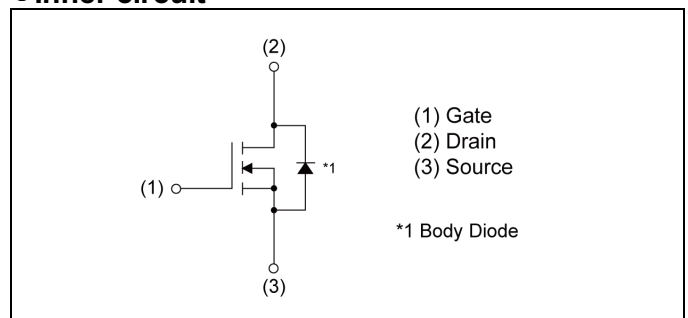

●Packaging specifications

Type	Packing	Tube
	Reel size (mm)	-
	Tape width (mm)	-
	Basic ordering unit (pcs)	360
	Taping code	C8
	Marking	R6020KNZ

●Absolute maximum ratings ($T_a = 25^\circ\text{C}$, unless otherwise specified)

Parameter	Symbol	Value	Unit
Drain - Source voltage	V_{DSS}	600	V
Continuous drain current ($T_c = 25^\circ\text{C}$)	I_D^{*1}	±20	A
Pulsed drain current	I_{DP}^{*2}	±60	A
Gate - Source voltage	static	±20	V
	AC($f > 1\text{Hz}$)	±30	V
Avalanche current, single pulse	I_{AS}	3.4	A
Avalanche energy, single pulse	E_{AS}^{*3}	418	mJ
Power dissipation ($T_c = 25^\circ\text{C}$)	P_D	68	W
Junction temperature	T_j	150	°C
Operating junction and storage temperature range	T_{stg}	-55 to +150	°C

● Thermal resistance

Parameter	Symbol	Values			Unit
		Min.	Typ.	Max.	
Thermal resistance, junction - case	R_{thJC}^{*4}	-	-	1.8	°C/W
Thermal resistance, junction - ambient	R_{thJA}	-	-	40	°C/W
Soldering temperature, wavesoldering for 10s	T_{sold}	-	-	265	°C

● Electrical characteristics ($T_a = 25^\circ\text{C}$)

Parameter	Symbol	Conditions	Values			Unit
			Min.	Typ.	Max.	
Drain - Source breakdown voltage	$V_{(BR)DSS}$	$V_{GS} = 0V, I_D = 1mA$	600	-	-	V
Zero gate voltage drain current	I_{DSS}	$V_{DS} = 600V, V_{GS} = 0V$	-	-	100	μA
		$T_j = 125^\circ\text{C}$	-	-	1000	
Gate - Source leakage current	I_{GSS}	$V_{GS} = \pm 20V, V_{DS} = 0V$	-	-	± 100	nA
Gate threshold voltage	$V_{GS(th)}$	$V_{DS} = 10V, I_D = 1mA$	3	-	5	V
Static drain - source on - state resistance	$R_{DS(on)}^{*5}$	$V_{GS} = 10V, I_D = 9.5A$	-	0.170	0.196	Ω
		$T_j = 125^\circ\text{C}$	-	0.360	-	
Gate resistance	R_G	$f = 1MHz, \text{open drain}$	-	2.3	-	Ω

●Electrical characteristics (T_a = 25°C)

Parameter	Symbol	Conditions	Values			Unit
			Min.	Typ.	Max.	
Forward Transfer Admittance	Y _{fs} ^{*5}	V _{DS} = 10V, I _D = 10A	5	10	-	S
Input capacitance	C _{iss}	V _{GS} = 0V	-	1550	-	pF
Output capacitance	C _{oss}	V _{DS} = 25V	-	1350	-	
Reverse transfer capacitance	C _{rss}	f = 1MHz	-	55	-	
Turn - on delay time	t _{d(on)} ^{*5}	V _{DD} ≈ 300V, V _{GS} = 10V	-	30	-	ns
Rise time	t _r ^{*5}	I _D = 10A	-	30	-	
Turn - off delay time	t _{d(off)} ^{*5}	R _L ≈ 30Ω	-	55	-	
Fall time	t _f ^{*5}	R _G = 10Ω	-	10	-	

●Gate charge characteristics (T_a = 25°C)

Parameter	Symbol	Conditions	Values			Unit
			Min.	Typ.	Max.	
Total gate charge	Q _g ^{*5}	V _{DD} ≈ 300V	-	40	-	nC
Gate - Source charge	Q _{gs} ^{*5}	I _D = 20A	-	12	-	
Gate - Drain charge	Q _{gd} ^{*5}	V _{GS} = 10V	-	15	-	
Gate plateau voltage	V _(plateau)	V _{DD} ≈ 300V, I _D = 20A	-	6.4	-	V

*1 Limited only by maximum channel temperature allowed.

*2 P_w ≤ 10μs, Duty cycle ≤ 1%

*3 L ≐ 70mH, V_{DD}=50V, R_G=25Ω, STARTING T_j=25°C

*4 T_C=25°C

*5 Pulsed

●Body diode electrical characteristics (Source-Drain) ($T_a = 25^\circ\text{C}$)

Parameter	Symbol	Conditions	Values			Unit
			Min.	Typ.	Max.	
Continuous forward current	I_S^{*1}	$T_C = 25^\circ\text{C}$	-	-	20	A
Pulse forward current	I_{SP}^{*2}		-	-	60	A
Forward voltage	V_{SD}^{*5}	$V_{GS} = 0\text{V}, I_S = 20\text{A}$	-	-	1.5	V
Reverse recovery time	t_{rr}^{*5}	$I_S = 20\text{A}$ $di/dt = 100\text{A}/\mu\text{s}$	-	500	-	ns
Reverse recovery charge	Q_{rr}^{*5}		-	7.5	-	μC
Peak reverse recovery current	I_{rm}^{*5}		-	30	-	A

●Typical transient thermal characteristics

Symbol	Value	Unit
R_{th1}	0.129	K/W
R_{th2}	0.627	
R_{th3}	1.22	

Symbol	Value	Unit
C_{th1}	0.00475	Ws/K
C_{th2}	0.0387	
C_{th3}	1.06	

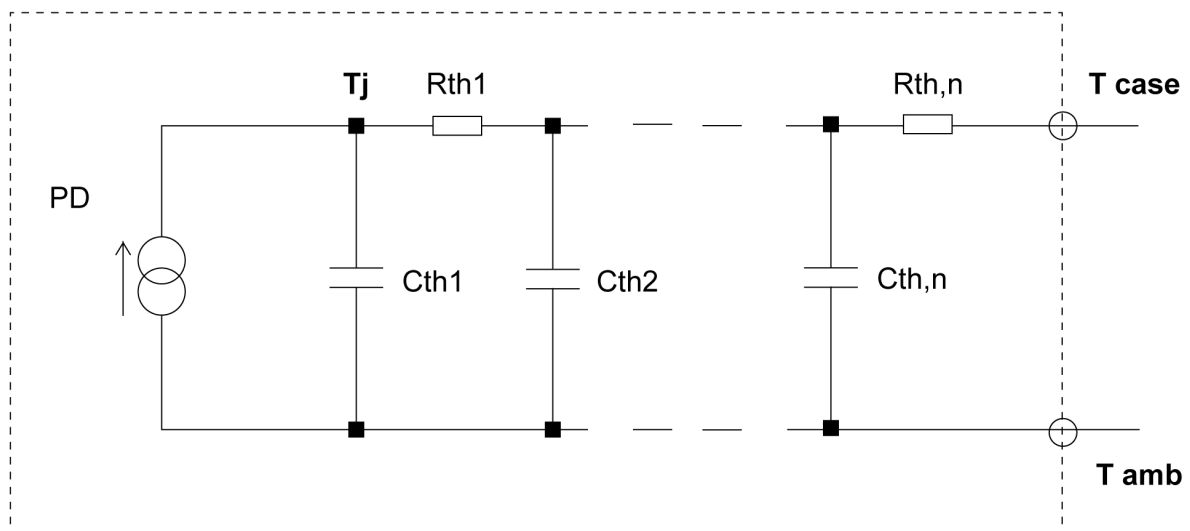

● Electrical characteristic curves

Fig.1 Power Dissipation Derating Curve

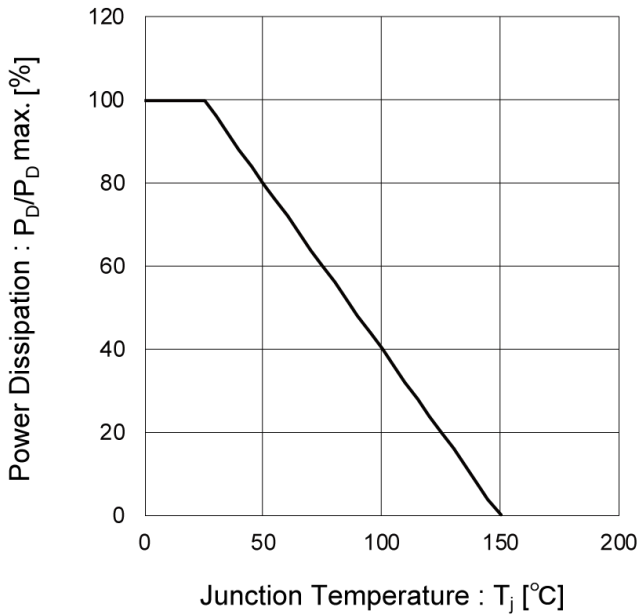

Fig.2 Maximum Safe Operating Area

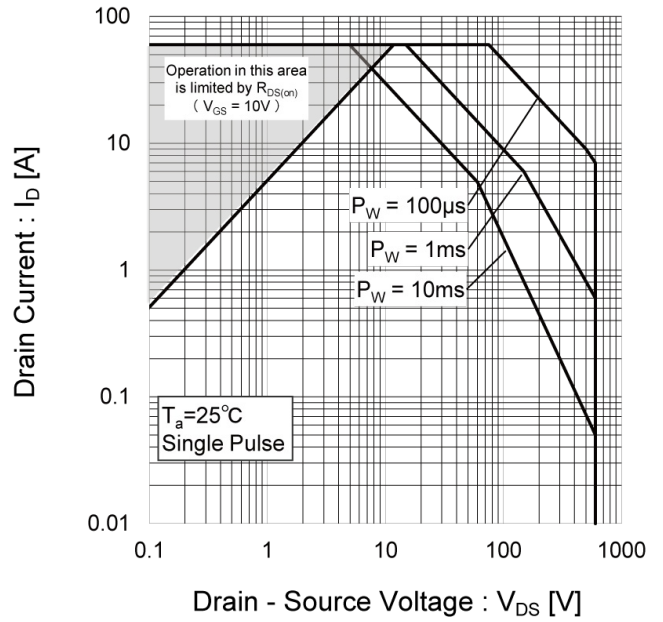
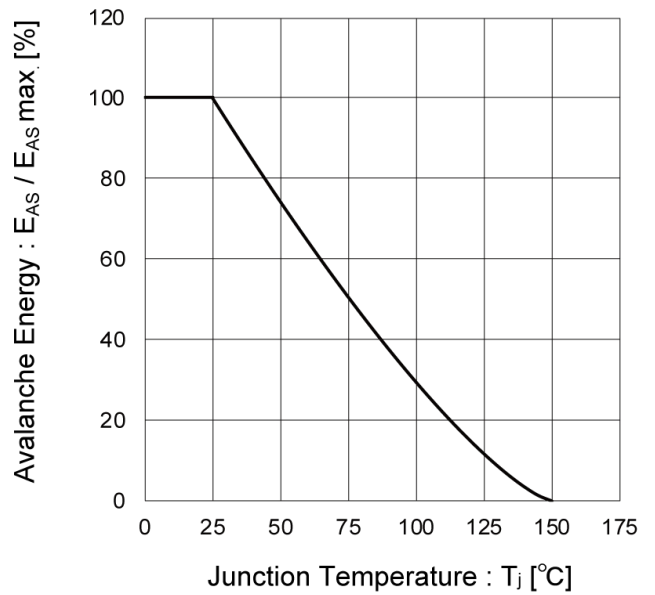

Fig.3 Avalanche Energy Derating Curve vs. Junction Temperature



● Electrical characteristic curves

Fig.4 Typical Output Characteristics(I)

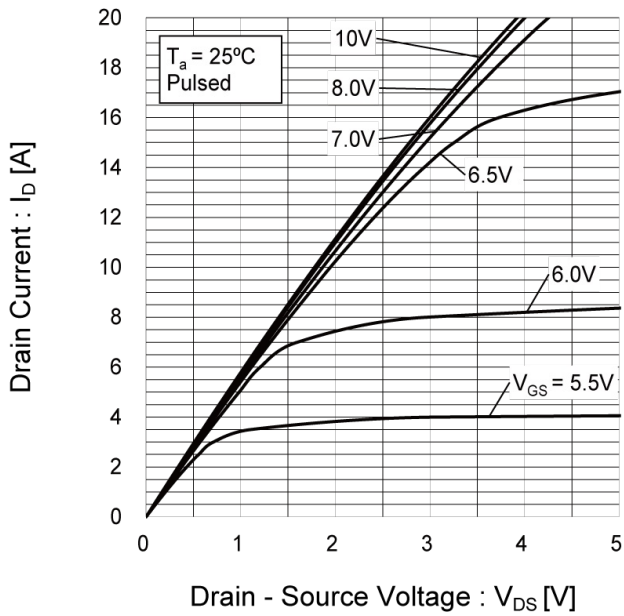
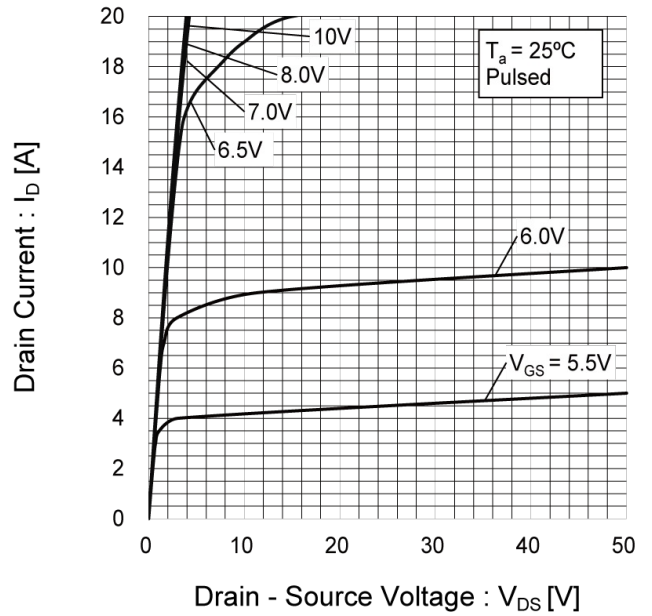

Fig.5 Typical Output Characteristics(II)



● Electrical characteristic curves

Fig.6 Breakdown Voltage vs. Junction Temperature

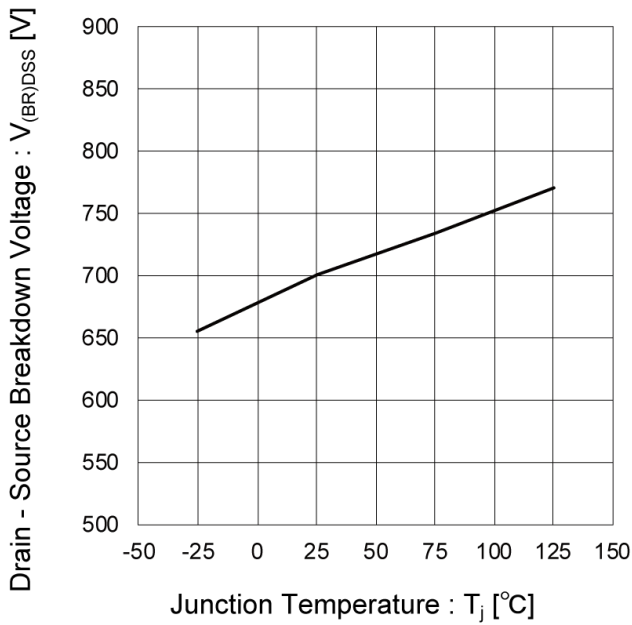

Fig.7 Typical Transfer Characteristics

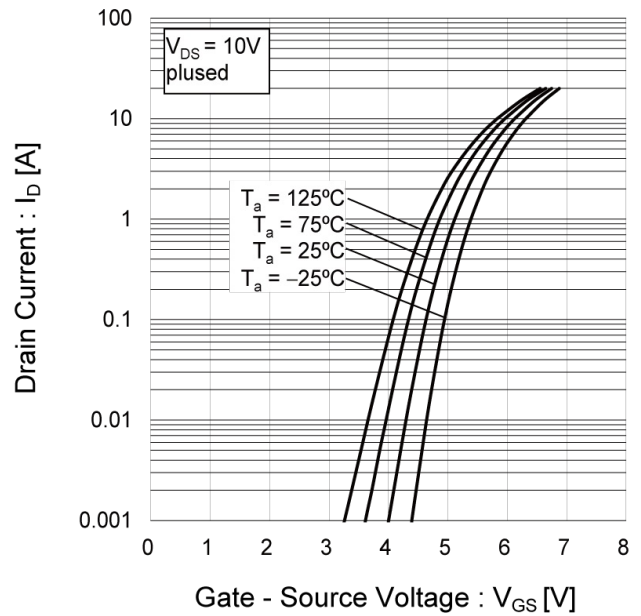

Fig.8 Gate Threshold Voltage vs. Junction Temperature

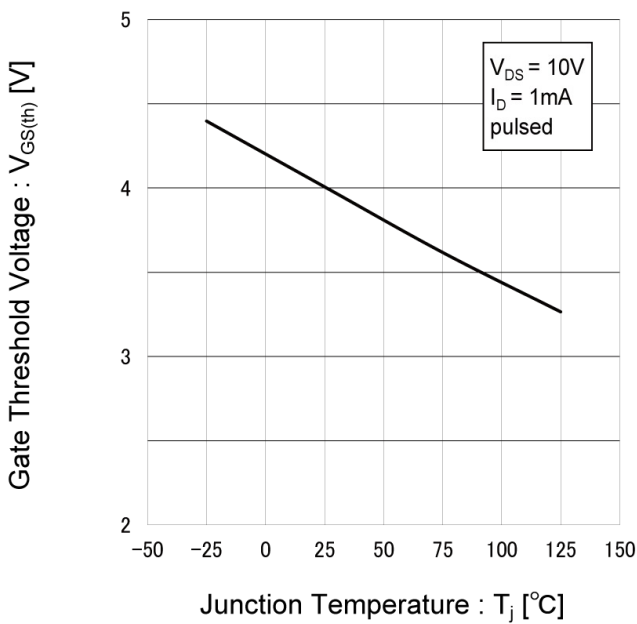
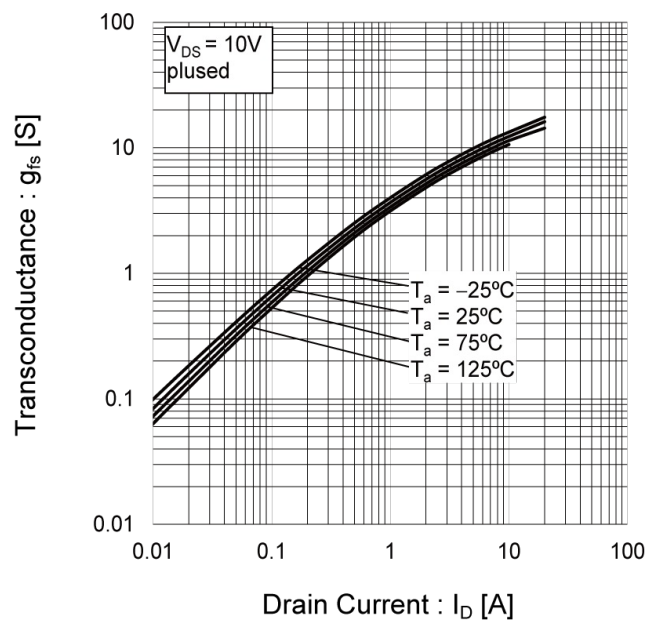

Fig.9 Forward Transfer Admittance vs. Drain Current



● Electrical characteristic curves

Fig.10 Static Drain - Source On - State Resistance vs. Gate Source Voltage

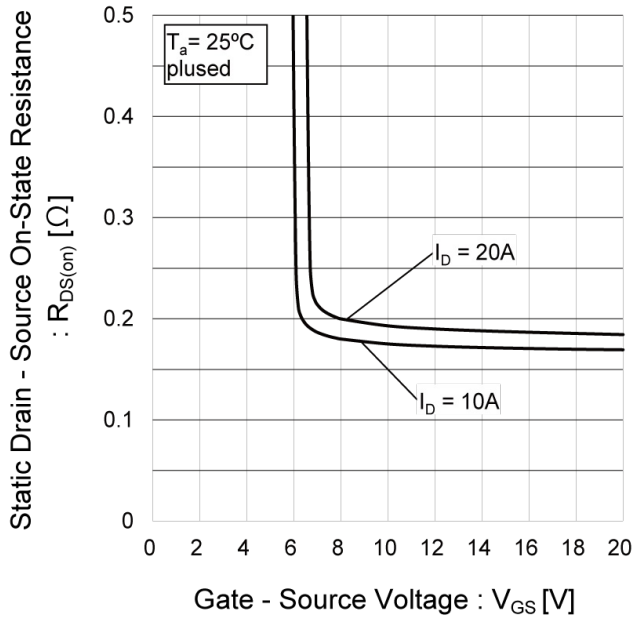

Fig.11 Static Drain - Source On - State Resistance vs. Junction Temperature

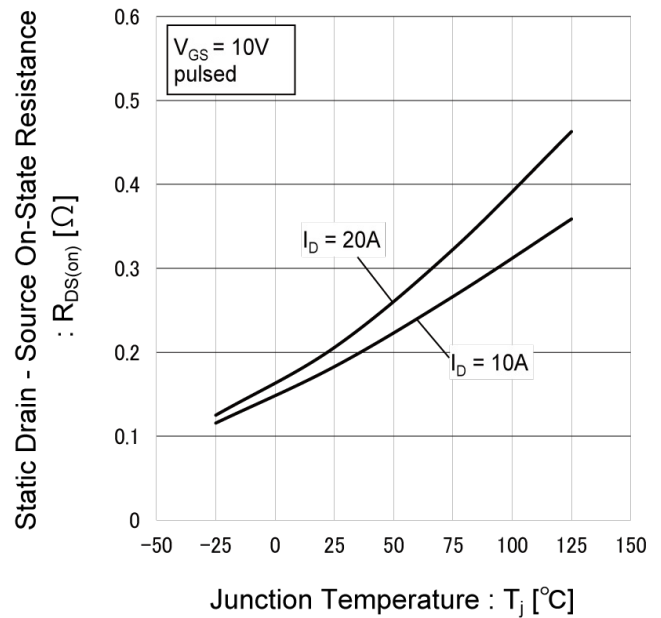
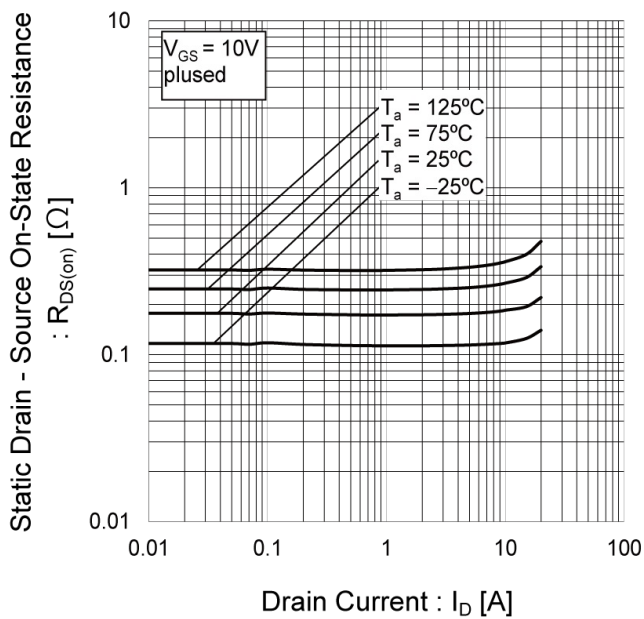

Fig.12 Static Drain - Source On - State Resistance vs. Drain Current(I)



● Electrical characteristic curves

Fig.13 Typical Capacitance vs. Drain - Source Voltage

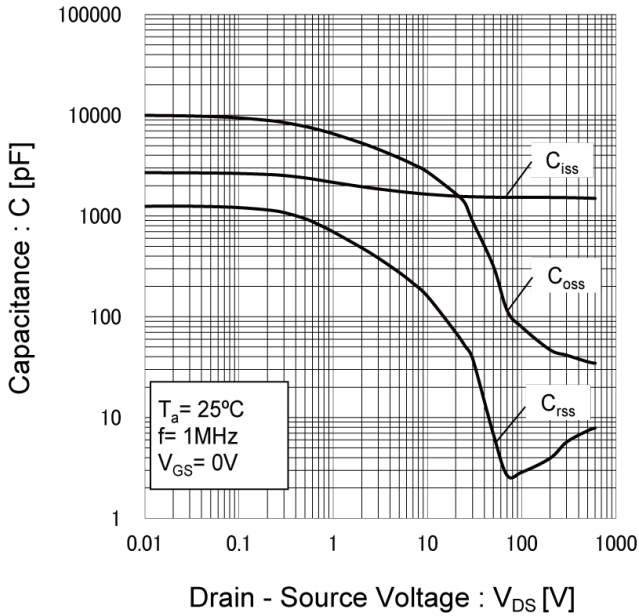

Fig.14 Switching Characteristics

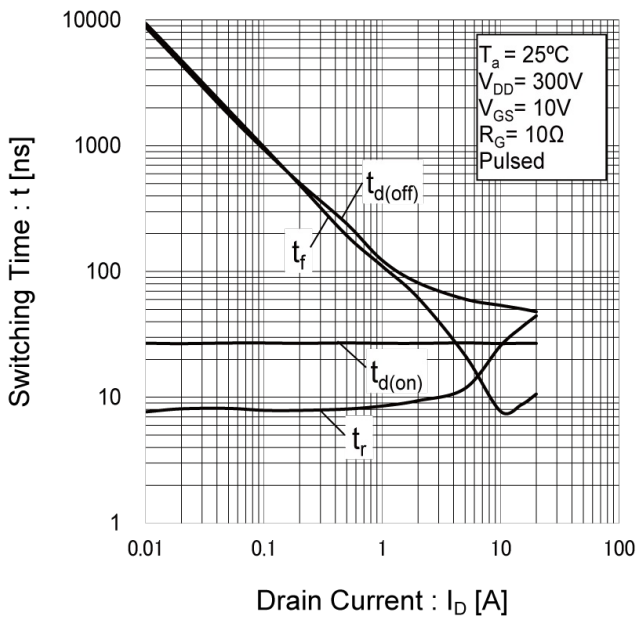
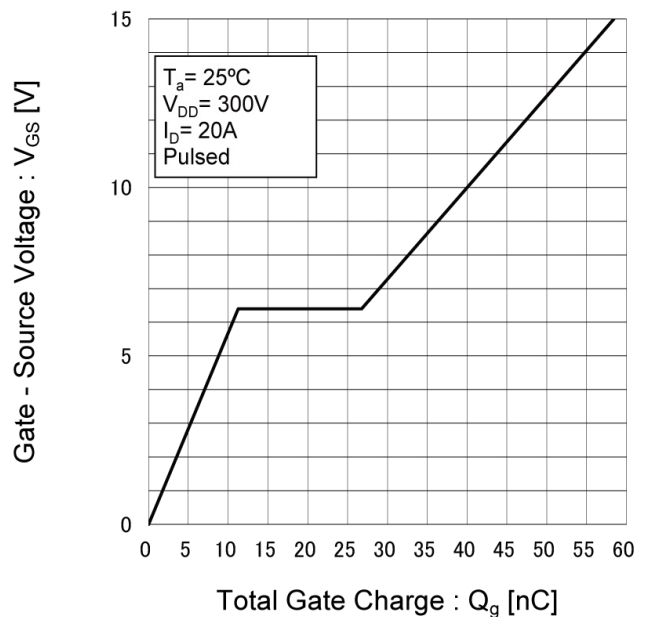

Fig.15 Dynamic Input Characteristics



● Electrical characteristic curves

Fig.16 Inverse Diode Forward Current vs. Source - Drain Voltage

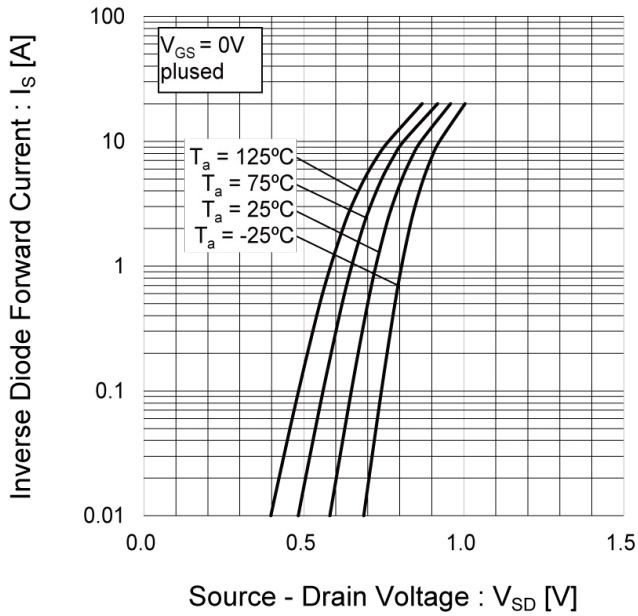
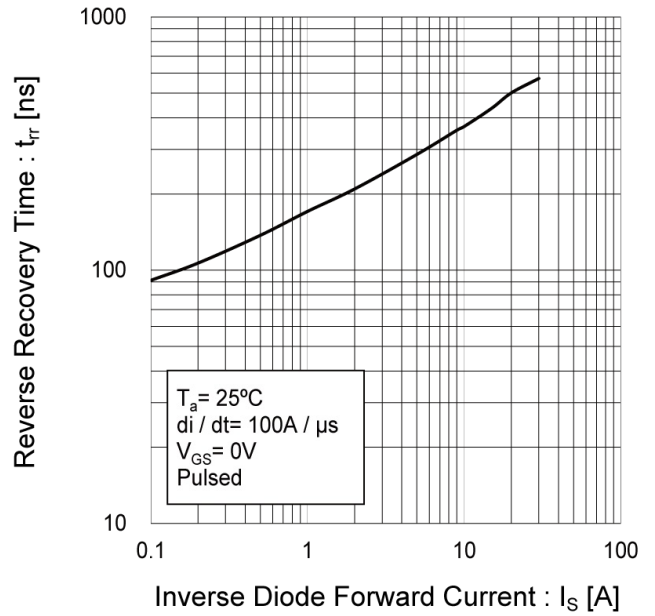

Fig.17 Reverse Recovery Time vs. Inverse Diode Forward Current



● Measurement circuits

Fig.1-1 Switching Time Measurement Circuit

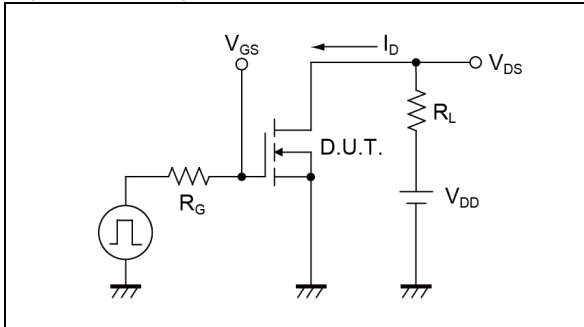

Fig.1-2 Switching Waveforms

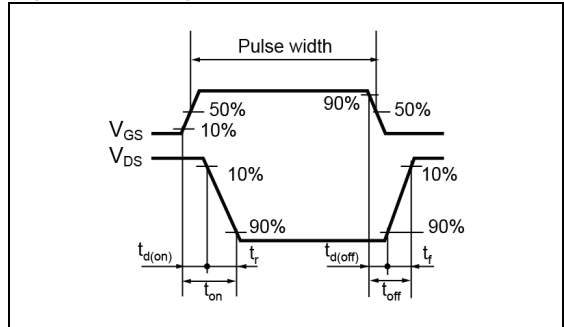

Fig.2-1 Gate Charge Measurement Circuit

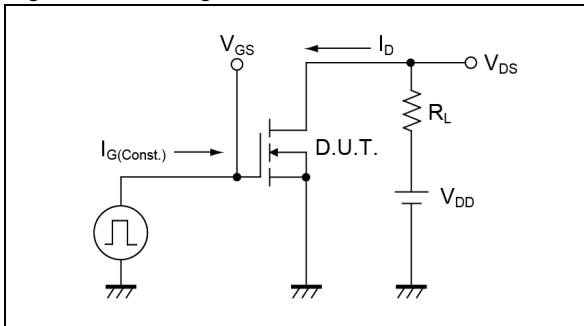

Fig.2-2 Gate Charge Waveform

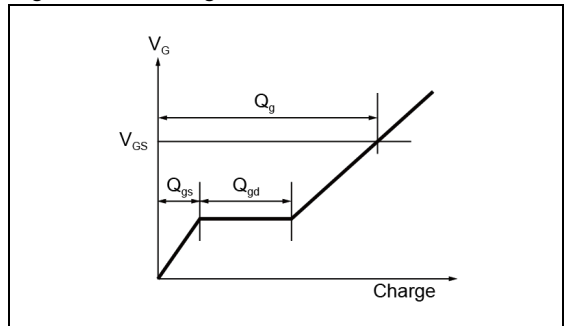

Fig.3-1 Avalanche Measurement Circuit

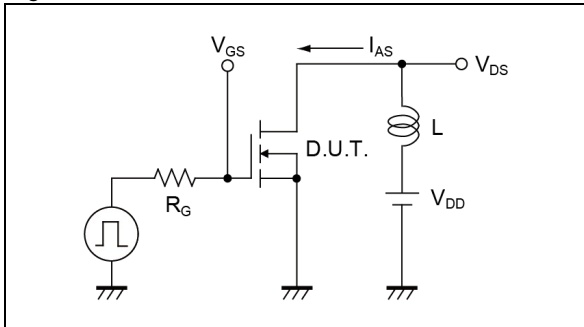

Fig.3-2 Avalanche Waveform

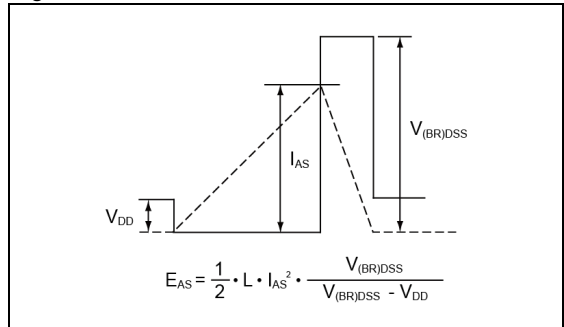

Fig.4-1 dv/dt Measurement Circuit

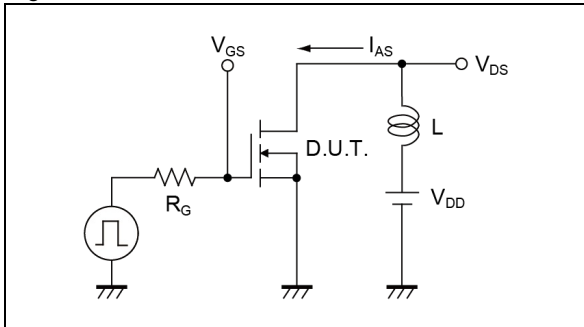

Fig.4-2 dv/dt Waveform

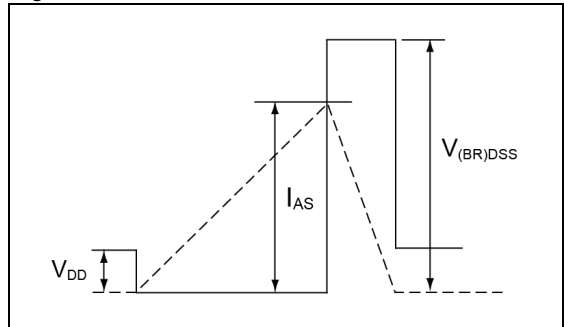

Fig.5-1 dv/dt Measurement Circuit

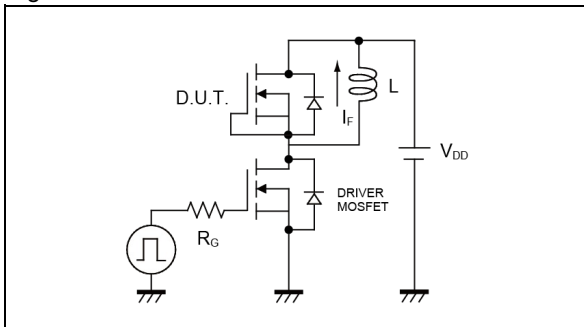
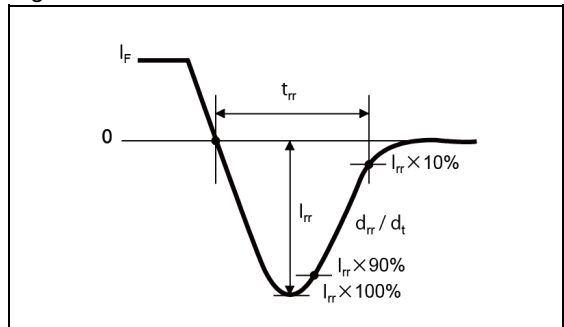
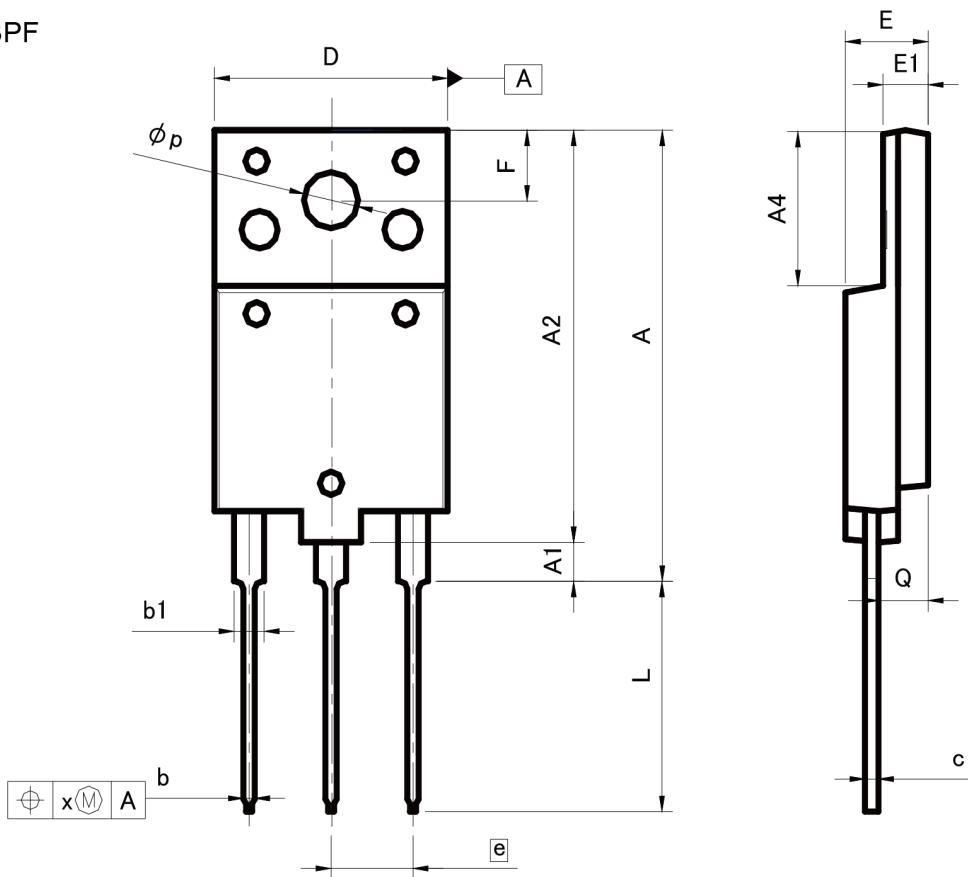

Fig.5-2 dv/dt Waveform



●Dimensions

TO-3PF



DIM	MILIMETERS		INCHES	
	MIN	MAX	MIN	MAX
A	26.30	26.70	1.035	1.051
A1	2.30	2.70	0.091	0.106
A2	26.30	26.70	1.035	1.051
A4	9.80	10.20	0.386	0.402
b	0.65	0.95	0.026	0.037
b1	1.80	2.20	0.071	0.087
c	0.80	1.10	0.031	0.043
D	15.30	15.70	0.602	0.618
E	5.30	5.70	0.209	0.224
e	5.45		0.215	-
E1	2.80	3.20	0.110	0.126
F	4.30	4.70	0.169	0.185
L	14.60	15.00	0.575	0.591
p	3.40	3.80	0.134	0.150
Q	3.10	3.50	0.122	0.138
x	-	0.50	-	0.020

Dimension in mm/inches

Notes

- 1) The information contained herein is subject to change without notice.
- 2) Before you use our Products, please contact our sales representative and verify the latest specifications :
- 3) Although ROHM is continuously working to improve product reliability and quality, semiconductors can break down and malfunction due to various factors.
Therefore, in order to prevent personal injury or fire arising from failure, please take safety measures such as complying with the derating characteristics, implementing redundant and fire prevention designs, and utilizing backups and fail-safe procedures. ROHM shall have no responsibility for any damages arising out of the use of our Products beyond the rating specified by ROHM.
- 4) Examples of application circuits, circuit constants and any other information contained herein are provided only to illustrate the standard usage and operations of the Products. The peripheral conditions must be taken into account when designing circuits for mass production.
- 5) The technical information specified herein is intended only to show the typical functions of and examples of application circuits for the Products. ROHM does not grant you, explicitly or implicitly, any license to use or exercise intellectual property or other rights held by ROHM or any other parties. ROHM shall have no responsibility whatsoever for any dispute arising out of the use of such technical information.
- 6) The Products are intended for use in general electronic equipment (i.e. AV/OA devices, communication, consumer systems, gaming/entertainment sets) as well as the applications indicated in this document.
- 7) The Products specified in this document are not designed to be radiation tolerant.
- 8) For use of our Products in applications requiring a high degree of reliability (as exemplified below), please contact and consult with a ROHM representative : transportation equipment (i.e. cars, ships, trains), primary communication equipment, traffic lights, fire/crime prevention, safety equipment, medical systems, servers, solar cells, and power transmission systems.
- 9) Do not use our Products in applications requiring extremely high reliability, such as aerospace equipment, nuclear power control systems, and submarine repeaters.
- 10) ROHM shall have no responsibility for any damages or injury arising from non-compliance with the recommended usage conditions and specifications contained herein.
- 11) ROHM has used reasonable care to ensure the accuracy of the information contained in this document. However, ROHM does not warrant that such information is error-free, and ROHM shall have no responsibility for any damages arising from any inaccuracy or misprint of such information.
- 12) Please use the Products in accordance with any applicable environmental laws and regulations, such as the RoHS Directive. For more details, including RoHS compatibility, please contact a ROHM sales office. ROHM shall have no responsibility for any damages or losses resulting non-compliance with any applicable laws or regulations.
- 13) When providing our Products and technologies contained in this document to other countries, you must abide by the procedures and provisions stipulated in all applicable export laws and regulations, including without limitation the US Export Administration Regulations and the Foreign Exchange and Foreign Trade Act.
- 14) This document, in part or in whole, may not be reprinted or reproduced without prior consent of ROHM.



Thank you for your accessing to ROHM product informations.
More detail product informations and catalogs are available, please contact us.

ROHM Customer Support System

<http://www.rohm.com/contact/>



R6020KNZ - Web Page

[Distribution Inventory](#)

Part Number	R6020KNZ
Package	TO-3PF
Unit Quantity	360
Minimum Package Quantity	360
Packing Type	Tube
Constitution Materials List	inquiry
RoHS	Yes