

RF Power LDMOS Transistors

High Ruggedness N-Channel Enhancement-Mode Lateral MOSFETs

These 1300 W RF power transistors are designed for applications operating at frequencies between 1020 and 1100 MHz. These devices are suitable for use in defense and commercial pulse applications, such as IFF and secondary surveillance radars.

Typical Performance: In 1030, 1090 MHz reference circuit, $V_{DD} = 50$ Vdc, $I_{DQ(A+B)} = 100$ mA

| Frequency (MHz) | Signal Type | P_{out} (W) | G_{ps} (dB) | η_D (%) |
|-----------------|--|---------------|---------------|--------------|
| 1030 (1) | Pulse (128 μ sec, 10% Duty Cycle) | 1300 Peak | 18.9 | 56.0 |
| 1090 (1) | | 1100 Peak | 18.8 | 57.9 |

Typical Narrowband Performance: $V_{DD} = 50$ Vdc, $I_{DQ(A+B)} = 100$ mA

| Frequency (MHz) | Signal Type | P_{out} (W) | G_{ps} (dB) | η_D (%) |
|-----------------|--|---------------|---------------|--------------|
| 1030 (2) | Pulse (128 μ sec, 10% Duty Cycle) | 1300 Peak | 18.2 | 58.1 |

Load Mismatch/Ruggedness

| Frequency (MHz) | Signal Type | VSWR | P_{in} (W) | Test Voltage | Result |
|-----------------|--|-------------------------------|------------------------|--------------|-----------------------|
| 1030 (2) | Pulse (128 μ sec, 10% Duty Cycle) | > 10:1 at all Phase Angles | 40 (3 dB Overdrive) | 50 | No Device Degradation |

1. Measured in 1030, 1090 MHz reference circuit.
2. Measured in 1030 MHz narrowband test circuit.

Features

- Internally input and output matched for broadband operation and ease of use
- Device can be used single-ended, push-pull, or in a quadrature configuration
- High ruggedness, handles > 10:1 VSWR
- Integrated ESD protection with greater negative voltage range for improved Class C operation and gate voltage pulsing
- Characterized with series equivalent large-signal impedance parameters

Applications

- Ground-based secondary surveillance radars
- IFF transponders

MMRF1317H MMRF1317HS

1030–1090 MHz, 1300 W PEAK, 50 V
RF POWER LDMOS TRANSISTORS

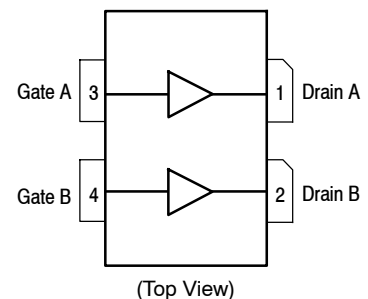
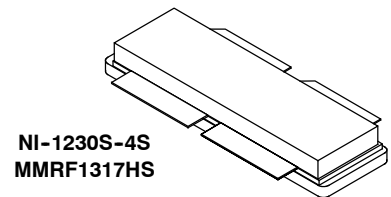
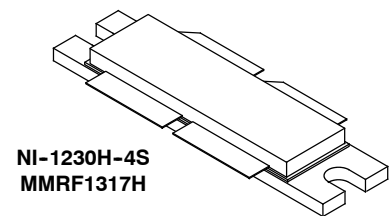

Note: The backside of the package is the source terminal for the transistor.

Figure 1. Pin Connections

Table 1. Maximum Ratings

| Rating | Symbol | Value | Unit |
|--|-----------|-------------|-----------|
| Drain-Source Voltage | V_{DSS} | -0.5, +105 | Vdc |
| Gate-Source Voltage | V_{GS} | -6.0, +10 | Vdc |
| Storage Temperature Range | T_{stg} | -65 to +150 | °C |
| Case Operating Temperature Range | T_C | -55 to +150 | °C |
| Operating Junction Temperature Range (1) | T_J | -55 to +225 | °C |
| Total Device Dissipation @ $T_C = 25^\circ\text{C}$ Derate above 25°C | P_D | 869 4.35 | W W/°C |

Table 2. Thermal Characteristics

| Characteristic | Symbol | Value (2) | Unit |
|--|-----------------|-----------|------|
| Thermal Impedance, Junction to Case Pulse: Case Temperature 70°C, 1300 W Peak, 128 μsec Pulse Width, 10% Duty Cycle, 50 Vdc, $I_{DQ(A+B)} = 100\text{ mA}$, 1030 MHz | $Z_{\theta JC}$ | 0.019 | °C/W |

Table 3. ESD Protection Characteristics

| Test Methodology | Class |
|---------------------------------------|-------------------|
| Human Body Model (per JESD22-A114) | 2, passes 2500 V |
| Machine Model (per EIA/JESD22-A115) | B, passes 250 V |
| Charge Device Model (per JESD22-C101) | IV, passes 2000 V |

Table 4. Electrical Characteristics ($T_A = 25^\circ\text{C}$ unless otherwise noted)

| Characteristic | Symbol | Min | Typ | Max | Unit |
|----------------|--------|-----|-----|-----|------|
|----------------|--------|-----|-----|-----|------|

Off Characteristics (3)

| | | | | | |
|--|---------------|-----|---|----|------------------|
| Gate-Source Leakage Current ($V_{GS} = 5\text{ Vdc}$, $V_{DS} = 0\text{ Vdc}$) | I_{GSS} | — | — | 1 | μA dc |
| Drain-Source Breakdown Voltage ($V_{GS} = 0\text{ Vdc}$, $I_D = 10\ \mu\text{A}$ dc) | $V_{(BR)DSS}$ | 105 | — | — | Vdc |
| Zero Gate Voltage Drain Leakage Current ($V_{DS} = 50\text{ Vdc}$, $V_{GS} = 0\text{ Vdc}$) | I_{DSS} | — | — | 1 | μA dc |
| Zero Gate Voltage Drain Leakage Current ($V_{DS} = 105\text{ Vdc}$, $V_{GS} = 0\text{ Vdc}$) | I_{DSS} | — | — | 10 | μA dc |

On Characteristics

| | | | | | |
|--|--------------|-----|-----|-----|-----|
| Gate Threshold Voltage (3) ($V_{DS} = 10\text{ Vdc}$, $I_D = 520\ \mu\text{A}$ dc) | $V_{GS(th)}$ | 1.3 | 1.7 | 2.3 | Vdc |
| Gate Quiescent Voltage (4) ($V_{DD} = 50\text{ Vdc}$, $I_{D(A+B)} = 100\text{ mA}$ dc, Measured in Functional Test) | $V_{GS(Q)}$ | 1.5 | 2.0 | 2.5 | Vdc |
| Drain-Source On-Voltage (3) ($V_{GS} = 10\text{ Vdc}$, $I_D = 2.6\text{ A}$ dc) | $V_{DS(on)}$ | 0.1 | 0.3 | 0.5 | Vdc |

Dynamic Characteristics (3)

| | | | | | |
|--|-----------|---|------|---|----|
| Reverse Transfer Capacitance ($V_{DS} = 50\text{ Vdc} \pm 30\text{ mV(rms)}$ ac @ 1 MHz, $V_{GS} = 0\text{ Vdc}$) | C_{rss} | — | 2.43 | — | pF |
|--|-----------|---|------|---|----|

1. Continuous use at maximum temperature will affect MTF.
2. Refer to AN1955, *Thermal Measurement Methodology of RF Power Amplifiers*. Go to <http://www.nxp.com/RF> and search for AN1955.
3. Each side of device measured separately.
4. Measurement made with device in push-pull configuration.

(continued)

Table 4. Electrical Characteristics ($T_A = 25^\circ\text{C}$ unless otherwise noted) (continued)

| Characteristic | Symbol | Min | Typ | Max | Unit |
|--|----------|------|------|------|------|
| Functional Tests ⁽¹⁾ (In Freescale Test Fixture, 50 ohm system) $V_{DD} = 50\text{ Vdc}$, $I_{DQ(A+B)} = 100\text{ mA}$, $P_{out} = 1300\text{ W Peak (130 W Avg.)}$, $f = 1030\text{ MHz}$, 128 μsec Pulse Width, 10% Duty Cycle | | | | | |
| Power Gain | G_{ps} | 17.4 | 18.2 | 19.1 | dB |
| Drain Efficiency | η_D | 55.0 | 58.1 | — | % |
| Input Return Loss | IRL | — | -12 | -9 | dB |

Load Mismatch/Ruggedness (In Freescale Test Fixture, 50 ohm system) $I_{DQ(A+B)} = 100\text{ mA}$

| Frequency (MHz) | Signal Type | VSWR | P_{in} (W) | Test Voltage, V_{DD} | Result |
|-----------------|--|----------------------------|------------------------|------------------------|-----------------------|
| 1030 | Pulse (128 μsec , 10% Duty Cycle) | > 10:1 at all Phase Angles | 40 (3 dB Overdrive) | 50 | No Device Degradation |

Table 5. Ordering Information

| Device | Tape and Reel Information | Package |
|--------------|--|----------------------|
| MMRF1317HR5 | R5 Suffix = 50 Units, 56 mm Tape Width, 13-inch Reel | NI-1230H-4S, Eared |
| MMRF1317HSR5 | | NI-1230S-4S, Earless |

1. Measurement made with device in push-pull configuration.

TYPICAL CHARACTERISTICS

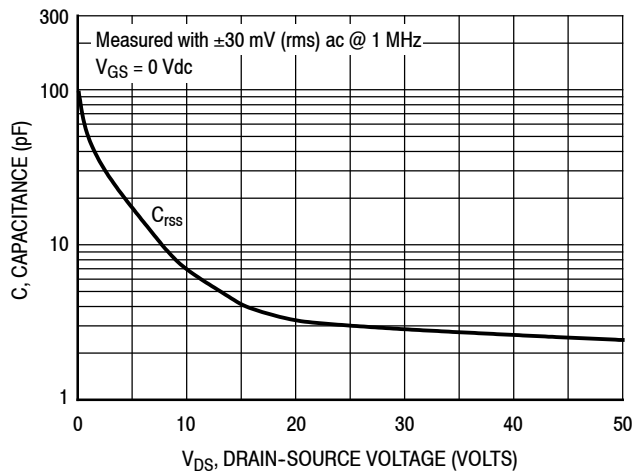

Note: Each side of device measured separately.

Figure 2. Capacitance versus Drain-Source Voltage

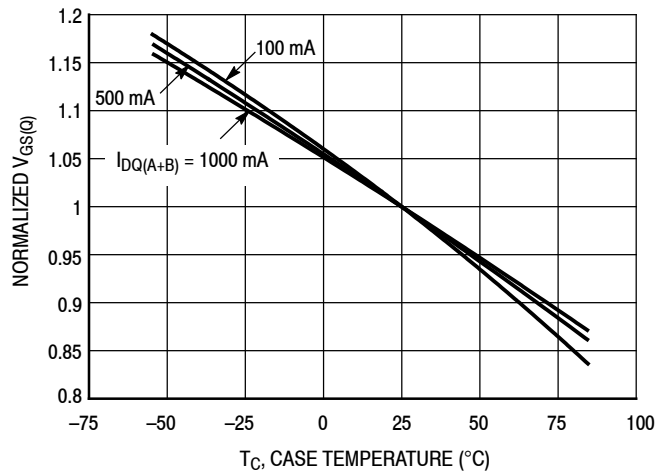

| I_{DQ} (mA) | Slope (mV/°C) |
|---------------|---------------|
| 100 | -2.46 |
| 500 | -2.21 |
| 1000 | -2.07 |

Figure 3. Normalized V_{GS} versus Quiescent Current and Case Temperature

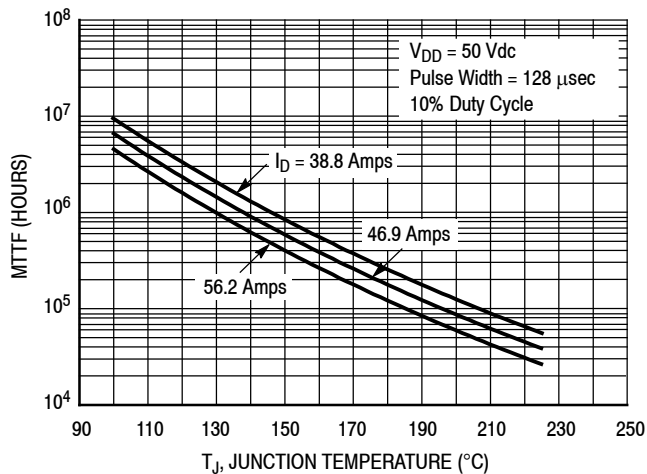

Note: MTTF value represents the total cumulative operating time under indicated test conditions.

Figure 4. MTTF versus Junction Temperature — Pulse

1030, 1090 MHz REFERENCE CIRCUIT — 2.0" x 4.0" (5.1 cm x 10.2 cm)

Table 6. 1030, 1090 MHz Performance (In Freescale Reference Circuit, 50 ohm system)

$V_{DD} = 50$ Vdc, $I_{DQ(A+B)} = 100$ mA

| Frequency (MHz) | Signal Type | G_{ps} (dB) | η_D (%) | P_{out} (W) |
|-----------------|--|---------------|--------------|---------------|
| 1030 | Pulse (128 μ sec, 10% Duty Cycle) | 18.9 | 56.0 | 1300 Peak |
| 1090 | | 18.8 | 57.9 | 1100 Peak |

1030, 1090 MHz REFERENCE CIRCUIT — 2.0" × 4.0" (5.1 cm × 10.2 cm)

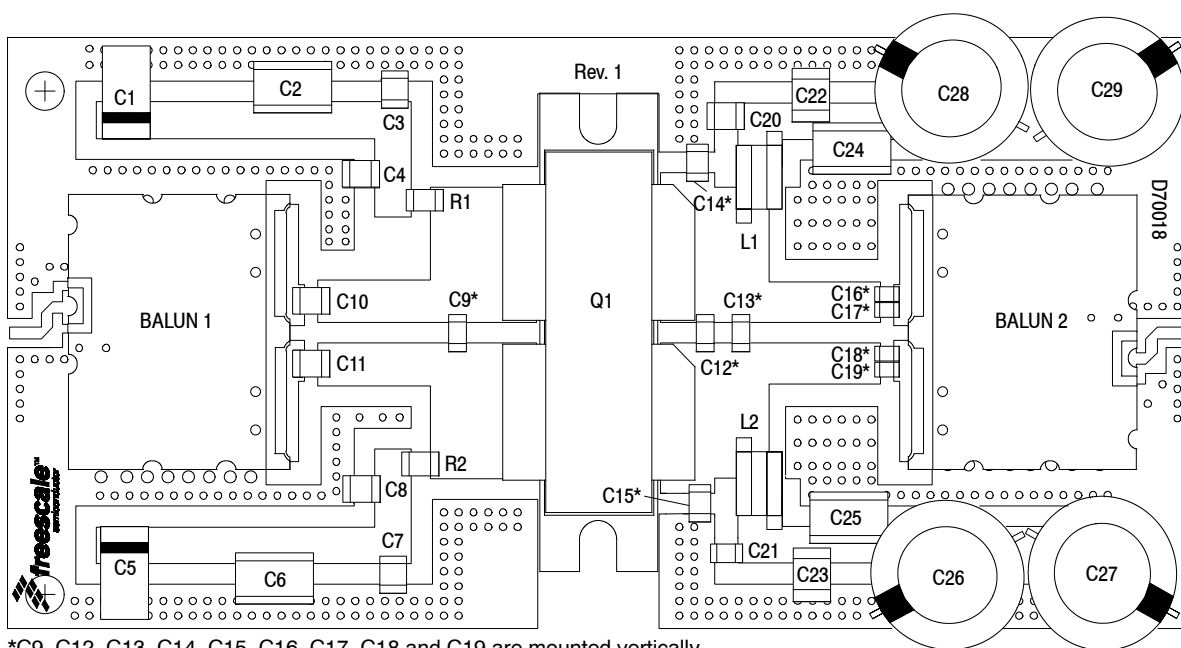

*C9, C12, C13, C14, C15, C16, C17, C18 and C19 are mounted vertically.

Figure 5. MMRF1317HR5 Reference Circuit Component Layout — 1030, 1090 MHz

Table 7. MMRF1317H(HS) Reference Circuit Component Designations and Values — 1030, 1090 MHz

| Part | Description | Part Number | Manufacturer |
|--|--|----------------------|--------------|
| Balun 1, 2 | 800–1000 MHz, 4-to-1 PCB Balun Transformers | 3A412S | Anaren |
| C1, C5 | 22 μ F, 35 V Tantalum Capacitors | T491X226K035AT | Kemet |
| C2, C6 | 2.2 μ F Chip Capacitors | C1825C225J5RACTU | Kemet |
| C3, C7 | 0.22 μ F Chip Capacitors | C1210C224K1RACTU | Kemet |
| C4, C8, C10, C11, C16, C17, C18, C19, C20, C21 | 36 pF Chip Capacitors | ATC100B360JT500XT | ATC |
| C9 | 5.1 pF Chip Capacitor | ATC800B5R1BT500XT | ATC |
| C12 | 6.2 pF Chip Capacitor | ATC800B6R2BT500XT | ATC |
| C13 | 1.6 pF Chip Capacitor | ATC800B1R5BT500XT | ATC |
| C14, C15 | 6.8 pF Chip Capacitors | ATC800B6R8BT500XT | ATC |
| C22, C23 | 0.47 μ F Chip Capacitors | HMK432B7474KM-T | Taiyo Yuden |
| C24, C25 | 0.022 μ F Chip Capacitors | C1825C223K1GACTU | Kemet |
| C26, C27, C28, C29 | 470 μ F, 63 V Electrolytic Capacitors | MCGPR63V477M13X26-RH | Multicom |
| L1, L2 | 27.4 nH, 3 Turn, #20 AWG ID = 0.125" Inductors, Hand Wound | 8050 | Belden |
| Q1 | RF Power LDMOS Transistor | MMRF1317HR5 | Freescale |
| R1, R2 | 1 k Ω , 1/4 W Chip Resistors | CRCW12061K00FKEA | Vishay |
| PCB | Rogers RO3010 0.050", $\epsilon_r = 11.2$ | D70018 | MTL |

TYPICAL CHARACTERISTICS — 1030, 1090 MHz
REFERENCE CIRCUIT

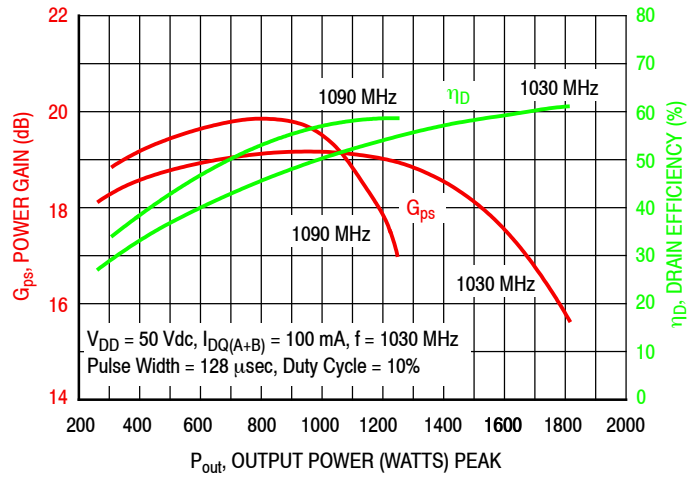
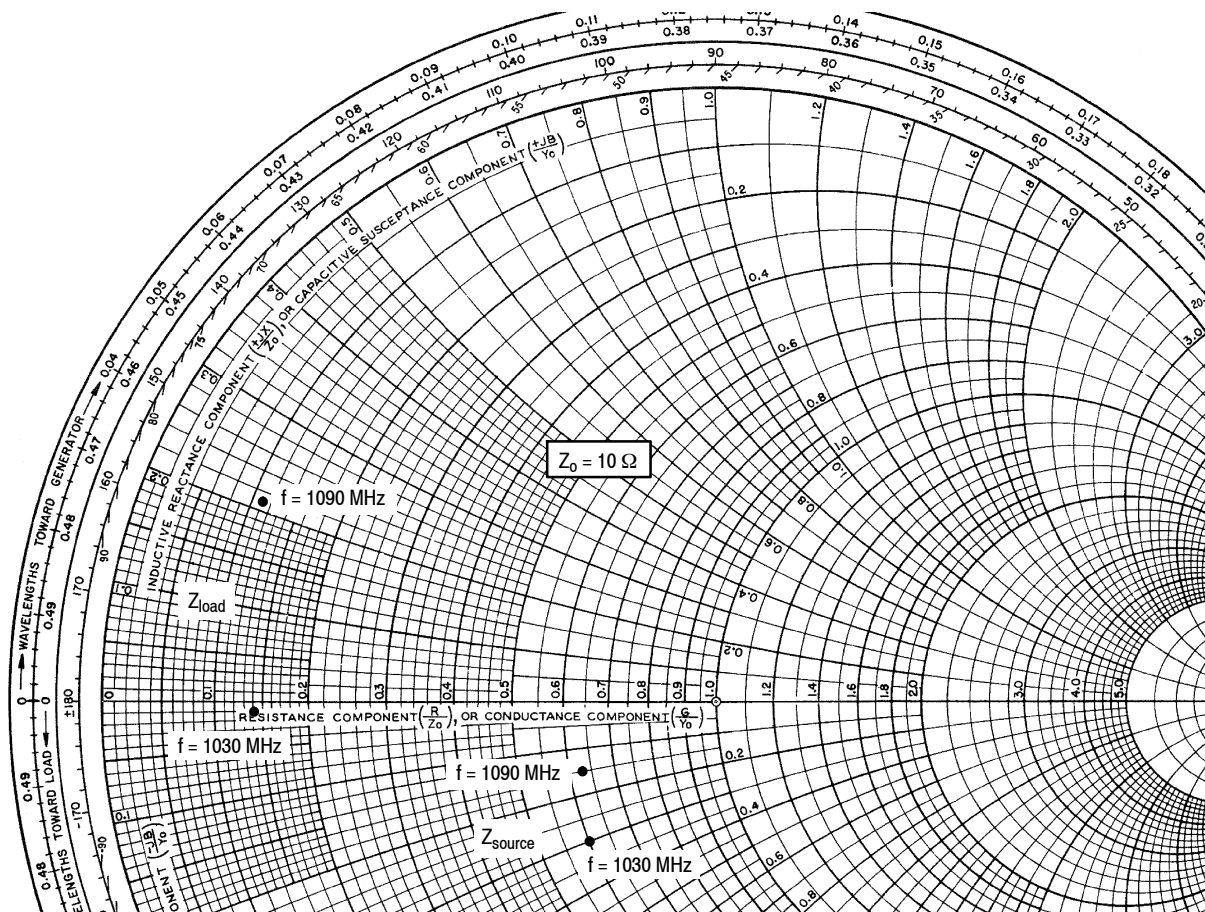

Figure 6. Power Gain and Drain Efficiency versus Output Power

1030, 1090 MHz REFERENCE CIRCUIT



| f MHz | Z _{source} Ω | Z _{load} Ω |
|----------|--------------------------|------------------------|
| 1030 | 6.03 - j2.97 | 1.41 - j0.13 |
| 1090 | 6.30 - j1.54 | 1.08 + j2.08 |

Z_{source} = Test circuit impedance as measured from gate to gate, balanced configuration.

Z_{load} = Test circuit impedance as measured from drain to drain, balanced configuration.

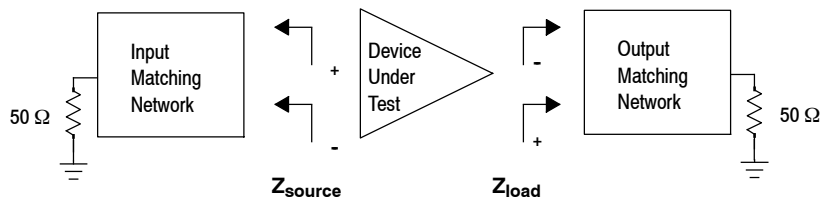

Figure 7. Series Equivalent Source and Load Impedance — 1030, 1090 MHz

1030 MHz NARROWBAND PRODUCTION TEST FIXTURE — 6.0" x 4.0" (15.2 cm x 10.2 cm)

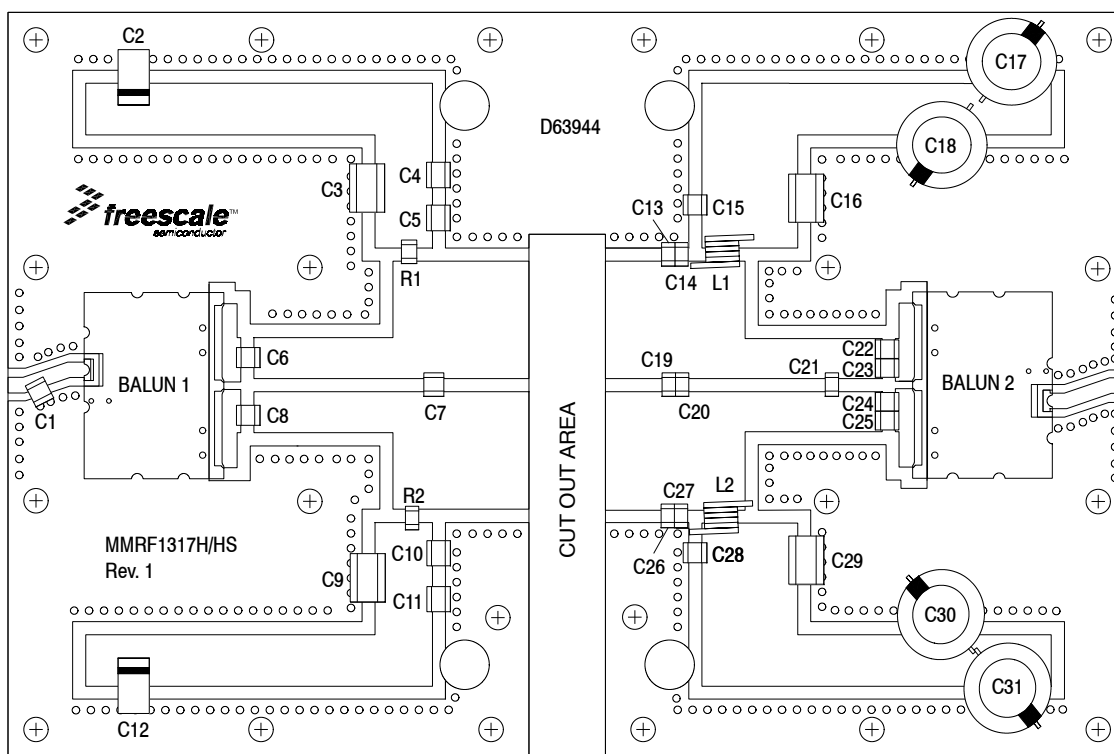

Figure 8. MMRF1317H(HS) Narrowband Test Circuit Component Layout — 1030 MHz

Table 8. MMRF1317H(HS) Narrowband Test Circuit Component Designations and Values — 1030 MHz

| Part | Description | Part Number | Manufacturer |
|---|---|----------------------|--------------|
| Balun 1, 2 | 800–1000 MHz, 4-to-1 PCB Balun Transformers | 3A412S | Anaren |
| C1 | 1.0 pF Chip Capacitor | ATC100B1R0JT500XT | ATC |
| C2, C12 | 22 μ F Tantalum Capacitors | T491X226K035AT | Kemet |
| C3, C9 | 2.2 μ F Chip Capacitors | C1825C225J5RACTU | Kemet |
| C4, C11 | 0.1 μ F Chip Capacitors | CDR33BX104AKWS | AVX |
| C5, C6, C8, C10, C15, C22, C23, C24, C25, C28 | 36 pF Chip Capacitors | ATC100B360JT500XT | ATC |
| C7 | 6.2 pF Chip Capacitor | ATC100B6R2JT500XT | ATC |
| C13, C19, C26 | 5.1 pF Chip Capacitors | ATC100B5R1JT500XT | ATC |
| C14, C27 | 2.0 pF Chip Capacitors | ATC800B2R0BT500XT | ATC |
| C16, C29 | 0.22 μ F Chip Capacitors | C1825C224K1RACTU | Kemet |
| C17, C18, C30, C31 | 470 μ F, 63 V Electrolytic Capacitors | MCGPR63V477M13X26-RH | Multicomp |
| C20 | 3.0 pF Chip Capacitor | ATC100B3R0JT500XT | ATC |
| C21 | 2.2 pF Chip Capacitor | ATC100B2R2JT500XT | ATC |
| L1, L2 | 12 nH Inductors | GA3094ALB | Coilcraft |
| R1, R2 | 100 Ω , 1/2 W Chip Resistors | CRCW2010100RFKFA | Vishay |
| PCB | Arlon AD255A, 0.030", $\epsilon_r = 2.55$ | D63944 | MTL |

TYPICAL CHARACTERISTICS — 1030 MHz PRODUCTION TEST FIXTURE

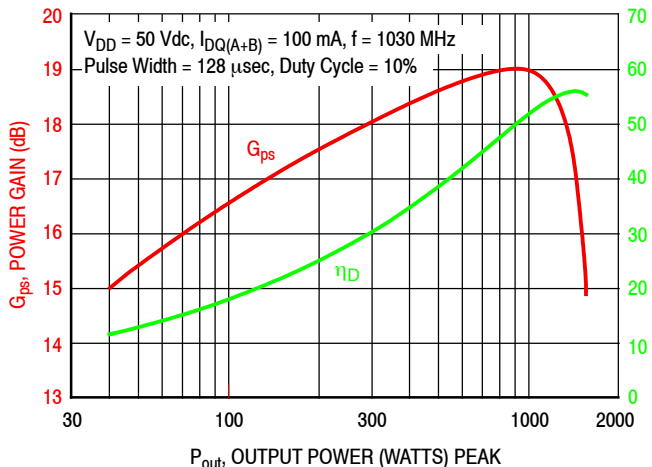

Figure 9. Power Gain and Drain Efficiency versus Output Power

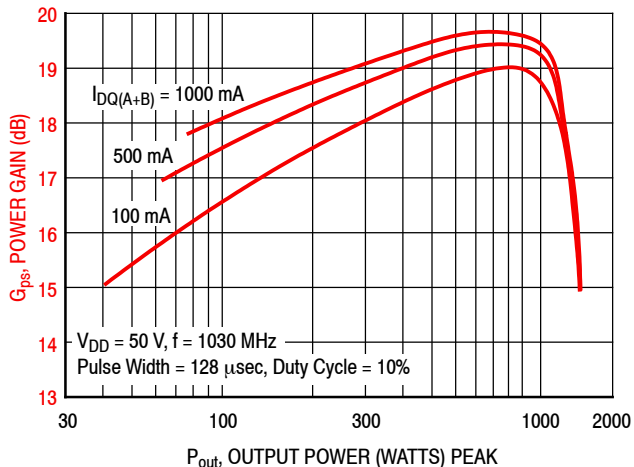

Figure 10. Power Gain versus Output Power and Quiescent Drain Current

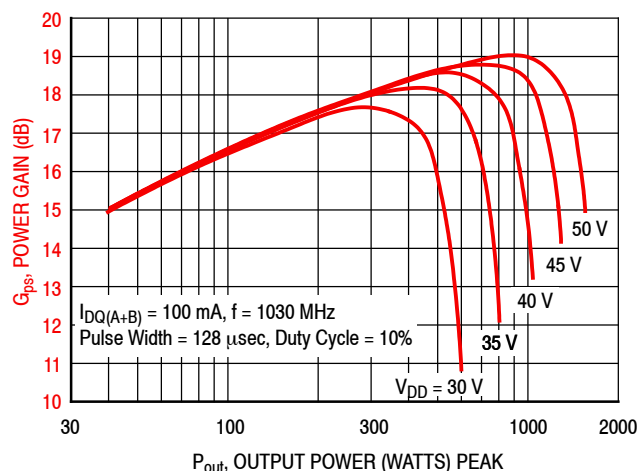
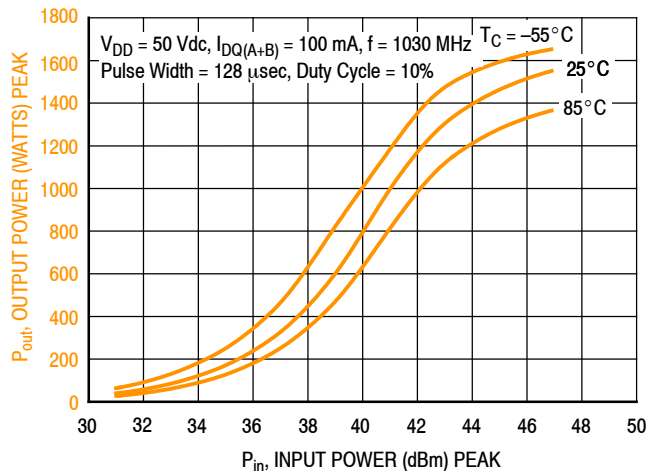

Figure 11. Power Gain versus Output Power and Drain Voltage



| f (MHz) | P1dB (W) | P3dB (W) |
|---------|----------|----------|
| 1030 | 1322 | 1498 |

Figure 12. Output Power versus Input Power

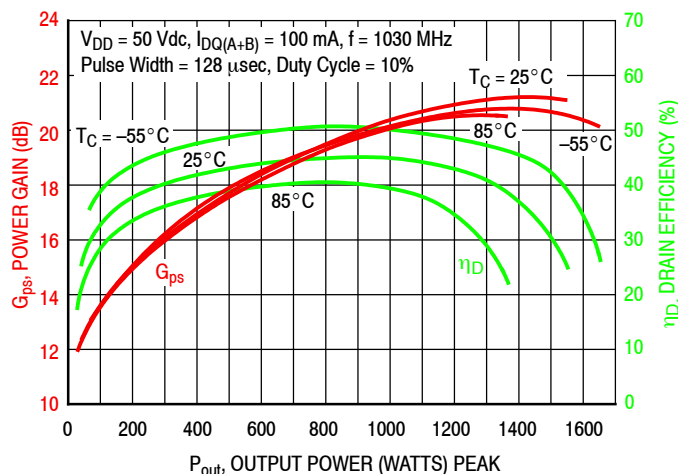

Figure 13. Power Gain and Drain Efficiency versus Output Power

1030 MHz NARROWBAND PRODUCTION TEST FIXTURE

| f MHz | Z_{source} Ω | Z_{load} Ω |
|----------|---------------------------------|-------------------------------|
| 1030 | $3.74 - j1.63$ | $2.29 - j0.19$ |

Z_{source} = Test circuit impedance as measured from gate to gate, balanced configuration.

Z_{load} = Test circuit impedance as measured from drain to drain, balanced configuration.

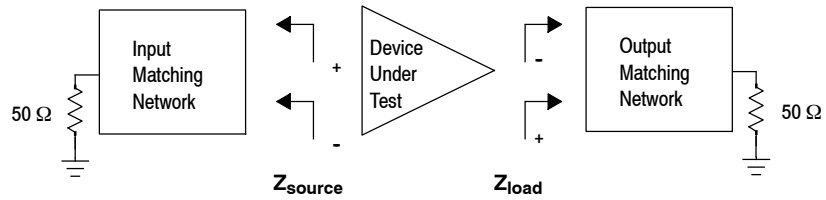
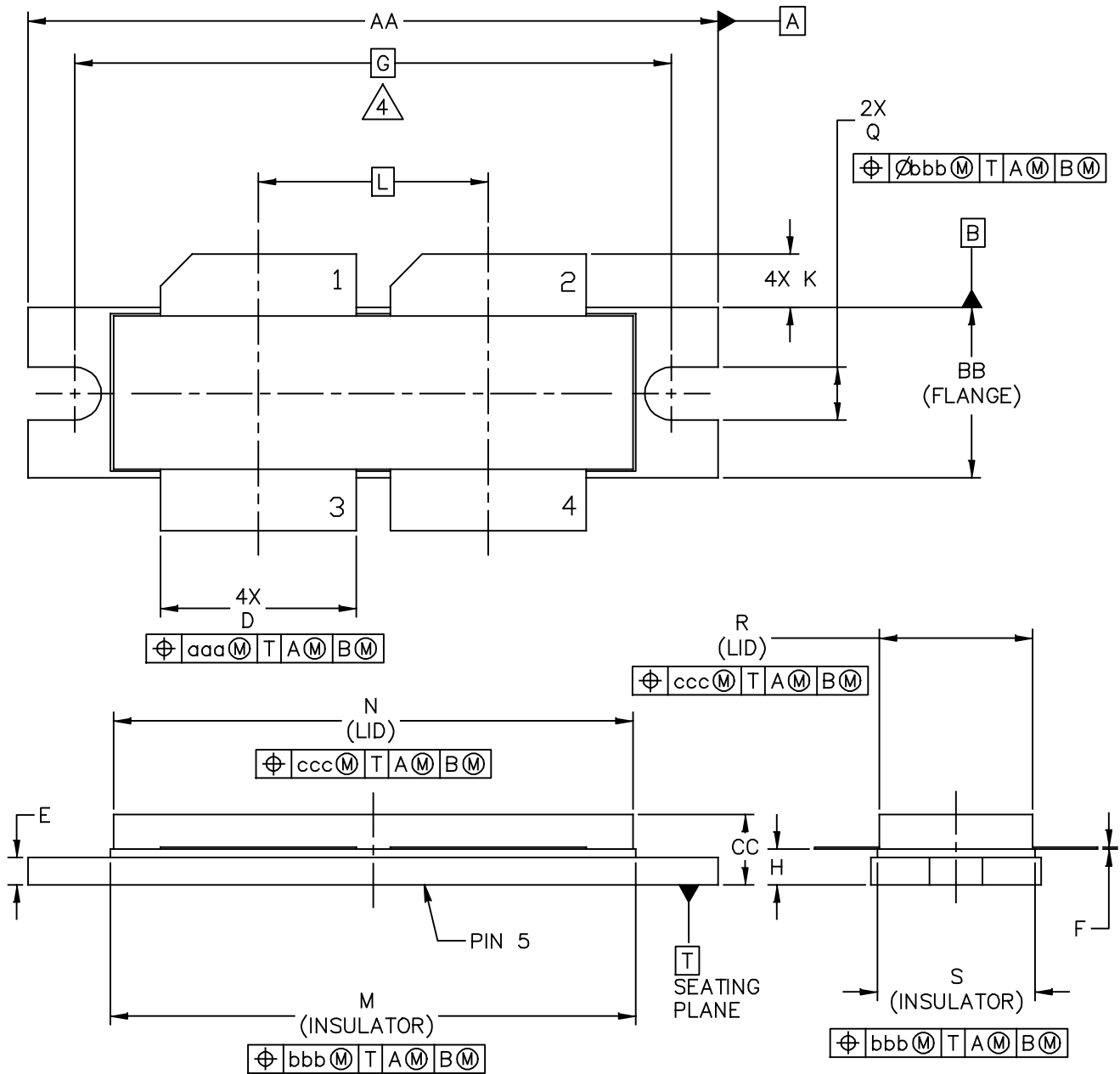

Figure 14. Series Equivalent Source and Load Impedance — 1030 MHz

PACKAGE DIMENSIONS



| | | |
|---|--------------------------|----------------------------|
| © FREESCALE SEMICONDUCTOR, INC. ALL RIGHTS RESERVED. | MECHANICAL OUTLINE | PRINT VERSION NOT TO SCALE |
| TITLE: NI-1230-4H | DOCUMENT NO: 98ASB16977C | REV: F |
| | STANDARD: NON-JEDEC | |
| | 28 FEB 2013 | |

NOTES:

1. INTERPRET DIMENSIONS AND TOLERANCES PER ASME Y14.5M-1994.
2. CONTROLLING DIMENSION: INCH
3. DIMENSION H IS MEASURED .030 INCH (0.762 MM) AWAY FROM PACKAGE BODY.
4. RECOMMENDED BOLT CENTER DIMENSION OF 1.52 INCH (38.61 MM) BASED ON M3 SCREW.

| DIM | INCH | | MILLIMETER | | DIM | INCH | | MILLIMETER | |
|---|-----------|-------|--------------------|-------|--------------------------|----------------------------|--------|------------|-------|
| | MIN | MAX | MIN | MAX | | MIN | MAX | MIN | MAX |
| AA | 1.615 | 1.625 | 41.02 | 41.28 | N | 1.218 | 1.242 | 30.94 | 31.55 |
| BB | .395 | .405 | 10.03 | 10.29 | Q | .120 | .130 | 3.05 | 3.30 |
| CC | .170 | .190 | 4.32 | 4.83 | R | .355 | .365 | 9.02 | 9.27 |
| D | .455 | .465 | 11.56 | 11.81 | S | .365 | .375 | 9.27 | 9.53 |
| E | .062 | .066 | 1.57 | 1.68 | | | | | |
| F | .004 | .007 | 0.10 | 0.18 | | | | | |
| G | 1.400 BSC | | 35.56 BSC | | aaa | .013 | | 0.33 | |
| H | .082 | .090 | 2.08 | 2.29 | bbb | .010 | | 0.25 | |
| K | .117 | .137 | 2.97 | 3.48 | ccc | .020 | | 0.51 | |
| L | .540 BSC | | 13.72 BSC | | | | | | |
| M | 1.219 | 1.241 | 30.96 | 31.52 | | | | | |
| © FREESCALE SEMICONDUCTOR, INC. ALL RIGHTS RESERVED. | | | MECHANICAL OUTLINE | | | PRINT VERSION NOT TO SCALE | | | |
| TITLE: | | | | | DOCUMENT NO: 98ASB16977C | | REV: F | | |
| NI-1230-4H | | | | | STANDARD: NON-JEDEC | | | | |
| | | | | | 28 FEB 2013 | | | | |

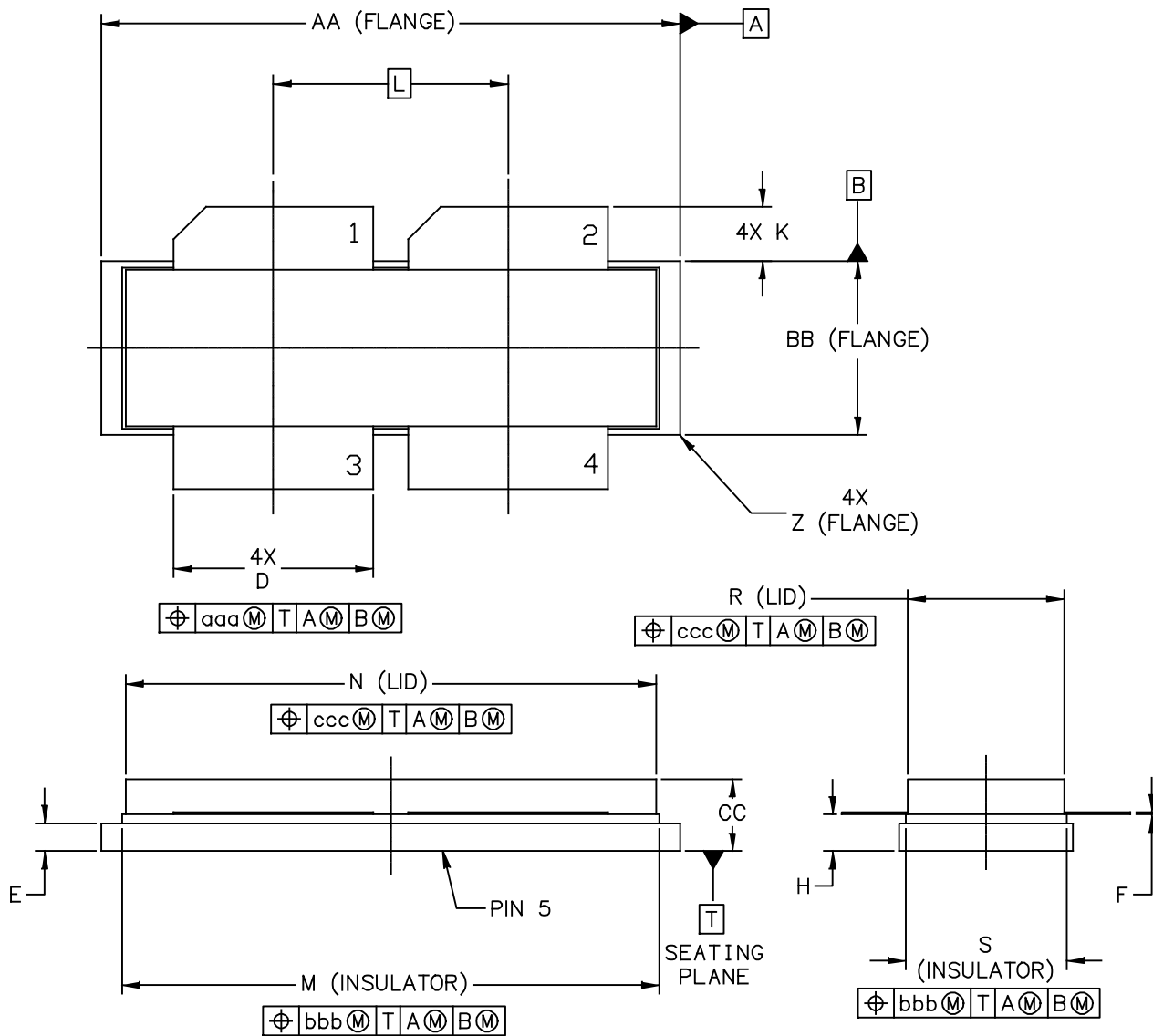

| | | |
|---|--------------------------|----------------------------|
| © NXP SEMICONDUCTORS N. V. ALL RIGHTS RESERVED | MECHANICAL OUTLINE | PRINT VERSION NOT TO SCALE |
| TITLE: NI-1230-4S | DOCUMENT NO: 98ARB18247C | REV: H |
| | STANDARD: NON-JEDEC | |
| | SOT1829-1 | 19 FEB 2016 |

NOTES:

1. INTERPRET DIMENSIONS AND TOLERANCES PER ASME Y14.5M-1994.
2. CONTROLLING DIMENSION: INCH
3. DIMENSION H IS MEASURED .030 INCH (0.762 MM) AWAY FROM PACKAGE BODY

| DIM | INCHES | | MILLIMETERS | | DIM | INCHES | | MILLIMETERS | |
|--|----------|-------|--------------------|-------|--------------------------------------|----------------------------|-------|-------------|-------|
| | MIN | MAX | MIN | MAX | | MIN | MAX | MIN | MAX |
| AA | 1.265 | 1.275 | 32.13 | 32.39 | R | .355 | .365 | 9.02 | 9.27 |
| BB | .395 | .405 | 10.03 | 10.29 | S | .365 | .375 | 9.27 | 9.53 |
| CC | .170 | .190 | 4.32 | 4.83 | Z | R.000 | R.040 | R0.00 | R1.02 |
| D | .455 | .465 | 11.56 | 11.81 | | | | | |
| E | .062 | .066 | 1.57 | 1.68 | aaa | .013 | | 0.33 | |
| F | .004 | .007 | 0.10 | 0.18 | bbb | .010 | | 0.25 | |
| H | .082 | .090 | 2.08 | 2.29 | ccc | .020 | | 0.51 | |
| K | .117 | .137 | 2.97 | 3.48 | | | | | |
| L | .540 BSC | | 13.72 BSC | | | | | | |
| M | 1.219 | 1.241 | 30.96 | 31.52 | | | | | |
| N | 1.218 | 1.242 | 30.94 | 31.55 | | | | | |
| © NXP SEMICONDUCTORS N.V. ALL RIGHTS RESERVED | | | MECHANICAL OUTLINE | | | PRINT VERSION NOT TO SCALE | | | |
| TITLE: NI-1230-4S | | | | | DOCUMENT NO: 98ARB18247C REV: H | | | | |
| | | | | | STANDARD: NON-JEDEC | | | | |
| | | | | | SOT1829-1 | | | 19 FEB 2016 | |

PRODUCT DOCUMENTATION

Refer to the following resources to aid your design process.

Application Notes

- AN1908: Solder Reflow Attach Method for High Power RF Devices in Air Cavity Packages
- AN1955: Thermal Measurement Methodology of RF Power Amplifiers

To Download Resources Specific to a Given Part Number:

1. Go to <http://www.nxp.com/RF>
2. Search by part number
3. Click part number link
4. Choose the desired resource from the drop down menu

REVISION HISTORY

The following table summarizes revisions to this document.

| Revision | Date | Description |
|----------|-----------|---------------------------------|
| 0 | Mar. 2016 | • Initial Release of Data Sheet |

How to Reach Us:

Home Page:
freescale.com

Web Support:
freescale.com/support

Information in this document is provided solely to enable system and software implementers to use Freescale products. There are no express or implied copyright licenses granted hereunder to design or fabricate any integrated circuits based on the information in this document.

Freescale reserves the right to make changes without further notice to any products herein. Freescale makes no warranty, representation, or guarantee regarding the suitability of its products for any particular purpose, nor does Freescale assume any liability arising out of the application or use of any product or circuit, and specifically disclaims any and all liability, including without limitation consequential or incidental damages. "Typical" parameters that may be provided in Freescale data sheets and/or specifications can and do vary in different applications, and actual performance may vary over time. All operating parameters, including "typicals," must be validated for each customer application by customer's technical experts. Freescale does not convey any license under its patent rights nor the rights of others. Freescale sells products pursuant to standard terms and conditions of sale, which can be found at the following address: freescale.com/SalesTermsandConditions.

Freescale and the Freescale logo are trademarks of Freescale Semiconductor, Inc., Reg. U.S. Pat. & Tm. Off. All other product or service names are the property of their respective owners.

© 2016 Freescale Semiconductor, Inc.



Mouser Electronics

Authorized Distributor

Click to View Pricing, Inventory, Delivery & Lifecycle Information:

[NXP:](#)

[MMRF1317HR5](#) [MMRF1317HSR5](#)